

chaffoteaux ltd.

Chaffoteaux  
et Maury

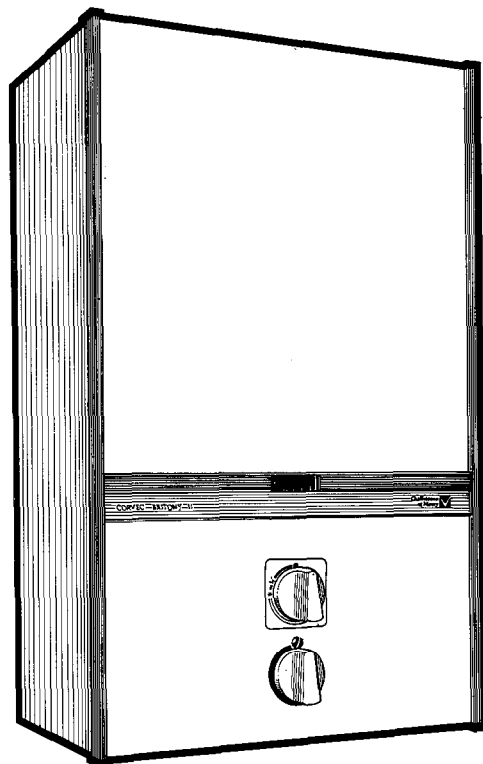

# CORVEC BRITONY II

CONFORMS WITH EUROPEAN STANDARD EN. 26

---

**installation**

**servicing instructions**

# contents

Page 3 : TECHNICAL DATA

Pages 4, 5 and 6 : INSTALLATION

Pages 7, 8 and 9 : SERVICING INSTRUCTIONS

Pages 10 and 11 : FAULT FINDING CHART FOR CORVEC BRITONY II

Page 12 : SHORT LIST

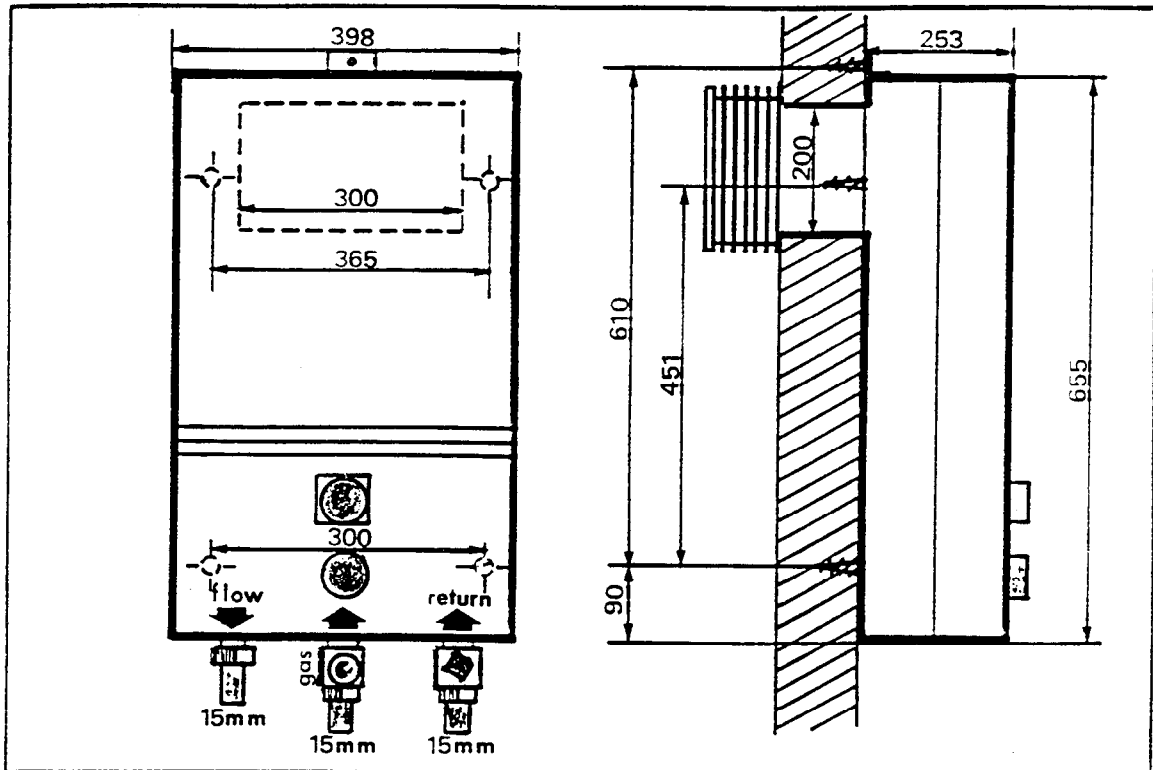

## GENERAL

The CORVEC Britony II is a balanced flue instantaneous gas fired multipoint water heater. Two models are available, a normal pressure version for direct connection to the mains cold water supply and a low pressure version for connection to a cold water storage tank.

The CORVEC Britony II does not require any purpose provided ventilation unless installed in a compartment. A compartment enclosing the heater requires high and low level openings communicating with outside air or the room in which the compartment is located. The free area of these openings must be :

	High Level	Low Level
Air from room	102 cm <sup>2</sup> (15.8 in <sup>2</sup> )	102 cm <sup>2</sup> (15.8 in <sup>2</sup> )
Air from outside	51 cm <sup>2</sup> ( 7.9 in <sup>2</sup> )	51 cm <sup>2</sup> ( 7.9 in <sup>2</sup> )

The installation of the heater must be in accordance with the relevant requirements of the Gas Safety Regulations, Building Regulations and the Byelaws of the local Water Undertaking. It should also be in accordance with any relevant requirements of the local gas region and local authority and the relevant recommendations of the following British Standard Codes of Practice.

CP 331 Installation of pipes and meters for town gas  
Part 3 - Low pressure installation pipes

CP 332 Selection and installation of town gas hot water supplies. Part 1 - Domestic premises

BS 5440 Flues and air supply for gas appliances of rated input not exceeding 60 kW (1st and 2nd family gases)  
Part 1 - Flues  
Part 2 - Air Supply

# technical data

## NATURAL GAS

TABLE 1

Heat input Nominal . . . . .	30.27 kW	103,280 Btu/h
Heat output Nominal . . . . .	22.70 kW	77,450 Btu/h
Gas rate (maximum) . . . . .	2.81 m <sup>3</sup> /h	99.24 ft <sup>3</sup> /h
Burner pressure . . . . .	15 mbar	6.0 ins
Main burner injectors marking . . . . .	113	-
Pilot injector marking . . . . .	23	-
Water flow rate - raised 50° C (90° F) . . . . .	6.5 l/m	1.44 g.p.m.
Water flow rate - raised 30° C (54° F) . . . . .	11.1 l/m	2.44 g.p.m.
Minimum operating head for normal pressure . . . . .	10 m	15 p.s.i.
Maximum operating head for normal pressure . . . . .	100 m	150 p.s.i.
Minimum operating head for low pressure . . . . .	3.5 m	11.5 ft
Maximum operating head for low pressure . . . . .	8 m	26 ft

Note : The minimum water pressure is for the correct operation of the heater only. An additional allowance must be made for the resistance of the pipework and fittings particularly where showers and washing machines are used. This should be the equivalent of 2 m (6.5 ft) head.

Water inlet . . . . .	Right hand connection	15 mm copper
Water outlet . . . . .	Left hand connection	15 mm copper
Gas . . . . .	Centre connection	15 mm copper
Height . . . . .	655 mm	26 in
Width . . . . .	395 mm	15.5 in
Depth . . . . .	253 mm	10 in
Weight . . . . .	19 kg	42 lb
Space for fixing - Top . . . . .	65 mm	2.6 ins
Space for fixing - Bottom . . . . .	178 mm	7.0 ins
Space for fixing - Sides . . . . .	NIL	NIL
Space for fixing - Front . . . . .	152 mm	6.0 ins
<b>HOLE FOR WALL LINER</b>		
Width . . . . .	305 mm	12 ins
Height . . . . .	205 mm	8 ins
<b>WALL THICKNESS</b>		
Standard flue set . . . . .	75-355 mm	3-14 ins
Optional flue set . . . . .	75-610 mm	3-24 ins

N.B. The low pressure model does not have a temperature selector knob

# installation

The CORVEC Britony II is supplied in two cartons, one containing the heater, the other containing the balanced flue set.

## INSTALLING THE BALANCED FLUE

The standard flue set is suitable for walls having a thickness of 75 mm (3 in) to 355 mm (14 in). An optional flue set for wall thicknesses up to 610 mm (24 in) is available to special order.

Detailed recommendations for flueing are given in BS 5440 : 1. The following notes are for general guidance only.

The heater must be installed so that the flue terminal is exposed to the external air. The heater must not be installed so that the terminal discharges into another room or space such as an outhouse or lean-to.

The terminal should be on a clear expanse of wall, the terminal preferably being not less than 600 mm (2 ft) away from a corner, recess or projection.

**DO NOT** install the terminal :

- a) within 300 mm (1 ft) measured vertically from the bottom of an openable window, air vent or any other ventilation opening.
- b) within 300 mm (1 ft) above adjacent ground level.
- c) within 600 mm (2 ft) of any surface facing the terminal.
- d) immediately beneath eaves or a balcony.

Where the lowest part of the terminal is less than 2 m (6.5 ft) above the level of any ground, balcony, flat roof or place to which any person has access, and which adjoins the wall in which the terminal is situated, the terminal must be protected by a guard of durable material. (A terminal guard is available from Chaffoteaux Limited).

The air inlet, product outlets duct or terminal of the heater must not be closer than 50 mm (2 in) to any combustible material. Detailed recommendations on the protection of combustible material are given in BS 5440 : 1.

## PREPARING THE WALL

The heater should be installed on a wall of flat non-combustible material that will not reverberate. Whatever the thickness of the wall, make a hole 305 mm (12 in) wide by 205 mm (8 in) high. If the hole is cut accurately there is no need to line it as the wall liner will seal off the cavity.

A minimum clearance of 80 mm (3.2 in) should be left above the top edge of the wall opening. For dimensions and clearance see Page 2 and Technical Data, Page 3.

Slide the wall liner through the wall ensuring that it is horizontal and that the flanged end is flush with the face of the inside wall. Trim to length if necessary, so that the outer end of the duct is flush with the face of the outside wall. Make good around the wall liner if necessary (fig. 1). **N.B.** For walls of between 75-100 mm (3-4 in), turn the wall liner hooks down through 90°.

## FITTING THE FLUE TERMINAL

The flue terminal may be fitted from inside or outside of the building by fixing the two spring loaded chains over the hooks on the inside of the wall liner (fig. 2).

Where the terminal is to be installed from inside the building, it can be passed through the wall liner and pulled back into position by using the chains. Where this procedure is used it must be ensured that there is no risk that the terminal can fall. It is recommended that a length of cord or string is fixed to the terminal to prevent any risk of damage to the terminal, the building, or to danger to persons in or about the building.

## INSTALLING THE HEATER

The heater is attached to the wall by 2 studs at the top and two screws at the bottom. A further optional top fixing is provided for installations where the wall adjacent to the top fixing holes is of less than sound construction. The fixing studs, screws and optional top bracket are packed with the gas service tap and a foam gasket and placed in a box which is found inside the heater.

Remove the front case of the heater by pulling off the gas control/temperature control knobs and unscrewing the three fixing screws at the top, bottom and between the control knobs. Pull off the front case taking care not to loose the rubber spacer behind the centre fixing screw.

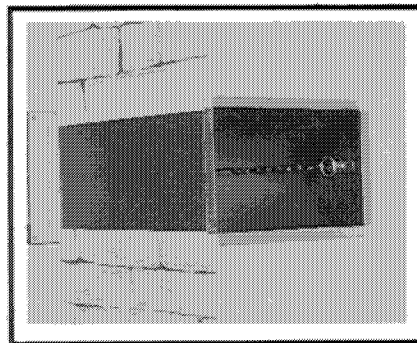
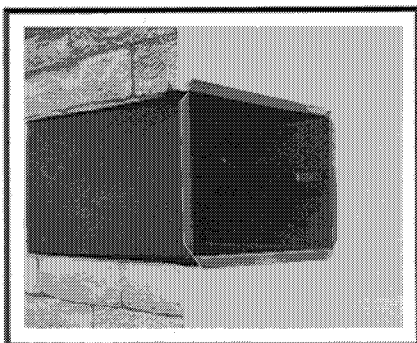

Fig. 1

Fig. 2

Fig. 3

# installation

Remove the flue bend from the top of the heat exchanger by releasing the fixing clip and removing the two screws.

N.B. If the optional top fixing bracket is to be used this should now be attached to the top of the rear case with the screws already fitted to the case (fig. 3).

Using the heater as a template, locate the spigot of the appliance in the wall liner, check that the appliance is vertical and mark the four or five fixing holes. Drill and plug the wall and fasten the top studs in position. These studs can be screwed into the wall by locking two nuts together on the parallel thread and using a spanner.

Attach the self adhesive foam gasket to the flat surface of the heater around the air inlet spigot of the rear case. Remove the protective paper while sticking down the gasket. Lift the heater into position on the wall, locating on the studs and the wall liner. Secure the heater to the wall using the nuts and screws provided. The hooks fit under the nuts of the top fixing studs (fig. 4).

Transfer the terminal fixing chains from the wall linet to these hoods. The terminal chains should not be left fixed to the wall liner hooks.

Slide the flue duct through the rectangular hole in the rear case and engage into the central spigot of the terminal so that it touches the two end stops. Refit the flue bend so that the flue duct engages by at least 25 mm (1 in). it may be necessary to cut the flue duct to the correct length, and ensure that the flue bend is seated correctly on the heat exchanger with the gasket in place. Replace the two screws and clip securing the flue bend.

Do not refit the front cover until the appliance has been commissioned.

## GAS CONNECTION

Remove the plastic cover from the gas inlet which is the centre connection on the bottom of the heater.

Fit the gas service tap provided using the fine filter washer to seal the connection. Fit the 15 mm dia. copper tail nut and washer provided to the inlet of the gas service tap and connect this to the gas supply.

The size of the gas supply pipe from the meter to the heater only should be as follows.

## Distance from Meter outlet to heater

0-3 m ( 0-10 ft)  
3-20 m (10-65 ft)  
20 m and above

## Gas Supply

15 mm  
22 mm  
contact British Gas

These sizes are for the heater only and do not take account of any other gas appliances that may be connected to the same gas service pipework.

## WATER CONNECTIONS

Remove the plastic covers protecting the water inlet and outlet connections.

Fit the water service tap provided to the right hand connection at the bottom of heater using the coarse filter washer to seal the connection.

Fit the 15 mm dia. copper tails and washers provided to the inlet of the water service tap and to the outlet of the heater (left hand connection).

The water service tap supplied with the heater incorporates a drain plug.

## APPLICATIONS OF THE CORVEC BRITONY II

The heater is designed to serve a variety of hot water draw-off points including washing machines and showers. The heater can be connected to all the hot water draw-off points in the installation, but it should be appreciated that depending upon the temperature selected, the water flow available will normally only be sufficient for simultaneous draw-off at a maximum of two points.

The heater is compatible with most current automatic washing machines, but care should be taken to ensure that the machine is capable of accepting water at the design flow rate of the heater. Hot and cold fill machines normally require a hot water temperature of 60° C (140° F), the heater producing approximately 6.5 l/m (1.44 gpm) at this temperature. The advice of the washing machine manufacturers should be sought, but generally it is only necessary to remove the water flow restrictor (if fitted) in the hot water inlet connection of the machine to obtain a satisfactory heater operation.

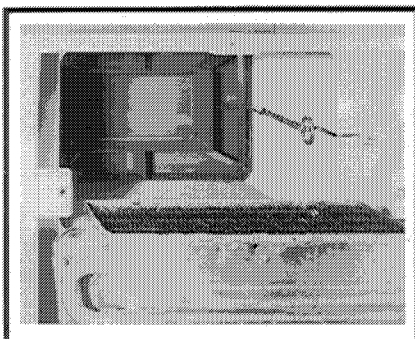

Fig. 4

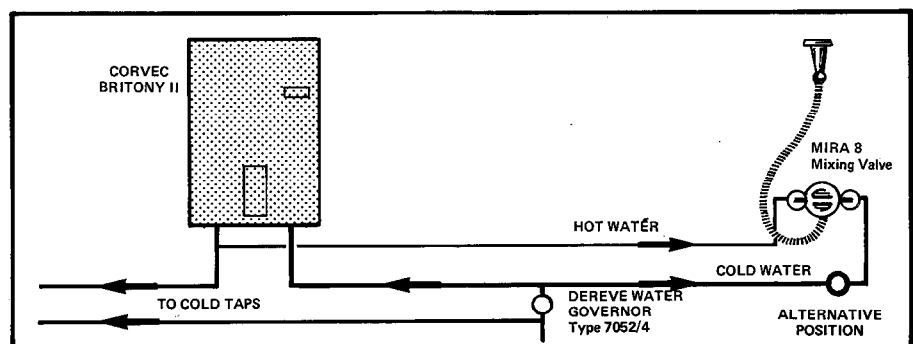

Fig. 5

# installation

Contact Chaffoteaux Limited for details of those machines known to be compatible with the CORVEC Britony II. The heater can be used to supply hot water to a separate shower draw-off. The heater should not be used to supply more than one shower mixing valve, but can supply two shower heads off a single mixing valve. The recommended pipework arrangement for a single shower head is shown in fig. 5. Only those fittings detailed should be used with the heater. Chaffoteaux Limited do not supply the water governor or any shower fittings. For local supplies of these please contact :

**Water Governor** Dereve (Flow Controls) Limited,  
Unit 11, Middlemore Industrial Estate,  
Middlemore Road, Smethwick, Warley,  
West Midlands  
Tel : 021 520 1337

**Shower Accessories** Walker Crosweiler & Co Limited,  
Whaddon Works, Cheltenham,  
Gloucestershire GL52 5EP  
Tel : 0242 27953

Do not use the heater with push-on hand showers that fit over existing hot and cold water taps.

## PIPEWORK

The following notes are for general guidance only.

- (i) the heater's performance may be affected if the installation has old pipework forming dead-legs or air reservoirs. Always ensure that any old pipework is either removed or capped off immediately adjacent to the pipework that will be in use.
- (ii) the size of pipework between the heater and the various draw-off points should be sized to ensure an adequate flow at all draw-offs when used individually.

## PUTTING INTO SERVICE

Open the gas and water service taps beneath the appliance. Purge the gas and water supplies. Check for gas and water soundness at all heater and external pipework connections.

Fit the gas control knob and light the pilot by turning the knob 90° anti-clockwise. It may be necessary to purge the pilot gas supply, if so, wait a few moments, return the gas control knob to the off position and repeat. (The pilot supply will only purge when the gas control knob has been turned 90° anti-clockwise).

Turn the gas control knob fully anti-clockwise to the main gas position. If the pilot is now extinguished for any reason, return the gas control knob to the off position and wait approximately 30 seconds for the safety interlock to reset itself.

Turn on an adjacent water draw-off point, the heater will now light.

Check the burner pressure by fitting a suitable gauge to the pressure test point on the end of the burner manifold. The correct pressure is given in Table 1, Page 3. If the burner pressure is not correct, check that the pressure at the gas tap test point is 20 mbar (8 ins w.g.) with the appliance operating. If the inlet pressure is not correct, check for any possible blockage or restriction in the pipework to the heater. If the pressure cannot be corrected contact your local gas region. The heat input to the heater is preset and non-adjustable.

For the low pressure model, adjustment of the water flow rate is necessary. With the burner pressure checked as before, adjust the water throttle (fig. 6) to give a temperature rise of 50° C (90° F). Screw in to increase the temperature and out to decrease it.

Remove the gas control knob.

Replace the front cover ensuring that the rubber spacer is in place behind the centre fixing screw. Refit all fixing screws. Replace the gas control knob and temperature control knob ensuring that the knob indicates "hot" when turned fully clockwise.

Hand the User's Instructions to the consumer and instruct in the correct and safe operation of the heater.

## DRAINING THE HEATER

If the heater is not to be used for long periods it is recommended that it be drained. See the Servicing Instructions for how to drain the heater.

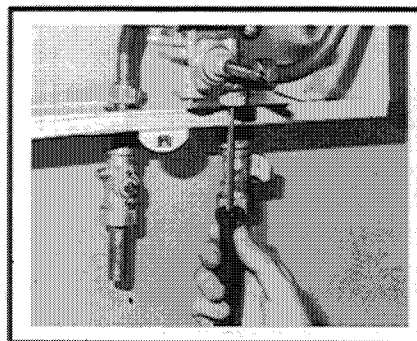

Fig. 6

# servicing instructions

Before commencing any servicing work, turn off the gas and water at the gas and water inlet taps on the appliance.

## RECOMMENDED SERVICING SCHEDULE

For efficient and trouble-free operation, it is recommended that the heater is serviced annually. The following work should be carried out by a competent person.

- i) Clean the burner
- ii) Clean the heating body (In hard water areas it may be necessary to descale the heating body)
- iii) Clean the pilot and thermocouple
- iv) Clean the gas and water filters
- v) Clean the water governor
- vi) Change the diaphragm every three years

### 1) FRONT CASING

To remove, pull off the gas control and temperature control knobs.

Unscrew the centre fixing screw between the control knobs and the top and bottom fixing screws.

Pull off the case taking care not to lose the rubber spacer behind the centre fixing point.

### 2) BURNER

Unscrew the pilot tube clamping screw (A - fig. 7) and remove the clamp and tube.

Remove the burner manifold by unscrewing the two screws (B - fig. 7).

Pull burner head assembly forward to remove, taking care not to trap the thermocouple or ignitor wires.

The burner head should be turned upside down and cleaned by brushing.

Replace in reverse order making sure that the gasket between the burner manifold and gas section is in place and that the burner head assembly is correctly located on the two spigots at the rear.

### 3) HEATING BODY

Remove the flue bend from the top of the heat exchanger by removing the clip and the two fixing screws. Lift the flue bend off the heat exchanger taking care not to damage the sealing gasket. The heating body can be examined in position, and if external cleaning is sufficient, remove the burner and clean the heat exchanger with a soft brush, detergent and hot water.

To remove the heating body for further cleaning, the heater must first be drained.

Turn off the water inlet tap to the appliance as before and open an adjacent hot water draw-off point. Remove the drain plug from the side of the water inlet tap (C - fig. 8) and drain the water from the heater. Alternatively remove the water governor plug (D - fig. 8) from the base of the water section and drain the water from the heater. Replace the drain down valve and/or water governor plug before proceeding.

Remove the burner (see section 2)

Remove the screw holding the bottom of the heating body skirt to the rear case.

Release the two union nuts joining the heating body legs to the water section.

Remove the heating body.

In hard water areas it may be necessary to descale the heating body. Use a solution consisting of 5 parts water to 1 part hydrochloric acid. The water should preferably be hot - ADD ACID TO WATER, NOT WATER TO ACID.

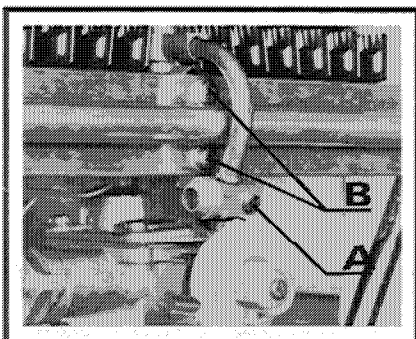

Fig. 7

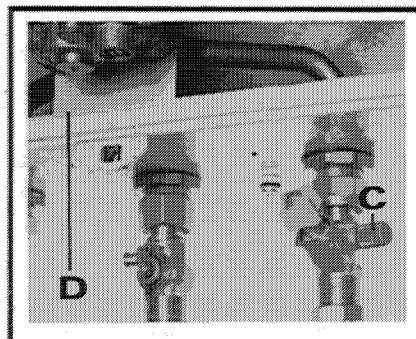

Fig. 8

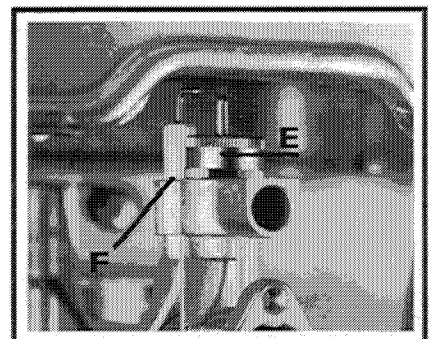

Fig. 9

# servicing instructions

Fill the heating body with this solution and leave until the solution stops bubbling. Flush out the heating body thoroughly before refitting to the heater.

**WARNING - ACID/WATER SOLUTIONS MUST BE USED WITH EXTREME CAUTION. TAKE CARE NOT TO SPLASH THE SOLUTION ONTO SKIN OR INTO THE EYES. WASH ANY AREAS AFFECTED WITH LARGE AMOUNTS OF COLD WATER AND SEEK MEDICAL ADVICE.**

Re-assemble in reverse order ensuring that the skirt fixing screw and reinforcing strip are in place.

## 4) PILOT

Unscrew the pilot tube clamping screw (A - fig. 7), and remove the clamp and tube.

Blow through the tube to remove any dust.

Remove the burner (see section 2).

Unscrew the knurled pilot burner outer ring (E - fig. 9).

Unscrew the pilot body (F - fig. 9), with a 15 mm spanner. Clean by blowing or washing in water. Do not clean the holes with a wire.

Blow any dust out of the gas section.

Re-assemble in reverse order.

## 5) THERMOCOUPLE

Remove the burner, see Section 2.

Remove the pilot, see Section 4.

Unscrew the thermocouple nut (G - fig. 10) from the thermo-electric valve and remove it from the wire.

With a 7 mm box spanner, unscrew the nut (H - fig. 11) holding the thermocouple into the gas section.

Thread the thermocouple and wire up through the gas section.

Replace in reverse order.

## 6) SPARK ELECTRODE

Remove the burner, see Section 2

Remove the electrode fixing screw (J - fig. 11) with a screwdriver placed inside the heating body skirt.

Pull off the electrode cable from the piezo cartridge.

Lift the electrode out of the gas section.

Re-assemble in reverse order, and note that the slot in the connector on the end of the electrode cable is vertical when pushed onto the cartridge.

## 7) THERMO-ELECTRIC VALVE

To replace, remove the thermocouple nut (G - fig. 10)

Unscrew cap from the side of the gas section and withdraw the thermo-electric valve.

**NOTE :** This heater is fitted with a safety interlock. When the pilot is turned off, the heater can not be relit until the thermocouple cools down and the lighting sequence is repeated.

## 8) MAIN GAS VALVE

To inspect and clean, remove the burner (see Section 2).

Disconnect the thermocouple and ignitor lead (see Section 5 and 6).

Remove the four screws fastening the top of the gas section to the base (K - fig. 12) and the two screws at the back (L - fig. 12), holding it to the rear case :

Lift the gas section top off the base.

Remove the complete gas valve assembly by unscrewing the brass cylinder that has two flats.

Dismantle the gas valve assembly by unscrewing the hexagonal spring retainer from the top of the assembly. Remove the spring and gas valve and clean the valve seating.

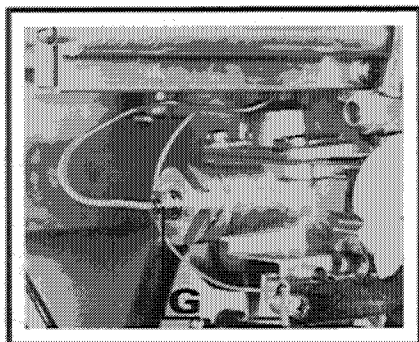

Fig. 10

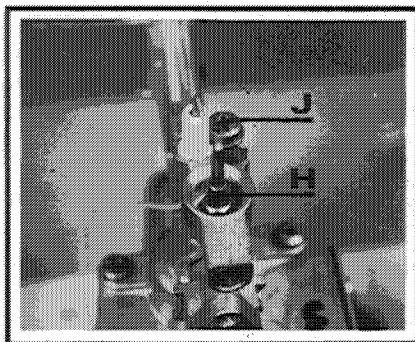

Fig. 11

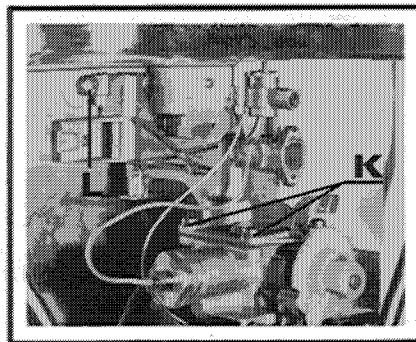

Fig. 12



# servicing instructions

Replace the gas valve facing rubber and gas valve assembly "O" ring if necessary.

Replace in reverse order, ensuring that the hexagonal spring retaining nut is screwed fully down and the whole assembly is screwed fully down into the gas section.

## 9) DIAPHRAGM

To replace, turn off the cold water supply and gas.

Drain the heater by removing the water governor plug situated in the base of the water section.

Unscrew the four water unions (M - fig. 13) on the water section.

Unscrew the six screws (N - fig. 13) holding the water section to the gas section.

Remove the water section complete with the diaphragm.

Replace in reverse order - NOTE - fit the water governor last. It is easier if the cold water inlet connection is partially engaged before fitting the screws and re-connecting the union nuts.

## 10) WATER GOVERNOR

To clean, turn off the cold water supply to the heater.

Remove the governor situated in the base of the water section (O - fig. 14).

Clean the components with water.

Check that the spring loaded piston moves freely.

Replace in reverse order.

## 11) GAS AND WATER FILTERS

Gas and water inlet filters are fitted between the inlet taps and the heater.

To clean, turn off the taps, unscrew the union nuts attaching the taps to the heater, and remove the filters.

Clean the filters by blowing or washing in water. DO NOT use any solvents.

Replace ensuring that the coarse filter is fitted in the water inlet and the fine filter in the gas inlet.

## 12) PIEZO CARTRIDGE

Pull off the electrode from the piezo cartridge.

Remove the screw holding the gas control cam and remove the cam (P - fig. 15).

Remove the two screws (Q - fig. 15) holding the retaining plate.

Remove the piezo cartridge and replace if necessary.

## 13) HEAT INPUT

The heat input is pre-set and non-adjustable. The heat input and burner pressure should be checked against Table 1.

If the heat input/burner pressure is not correct, check the working pressure at the pressure test point on the gas service tap. This should be 20 mbar (8 ins w.g.).

The gas installation should be examined for any possible blockage if the pressure is incorrect.

## 14) WATER SECTION VENTURI

Drain the heater as in Section 3.

Disconnect the right hand heating body leg at the water section and remove the venturi.

Clean or replace as necessary and re-assemble in reverse order.

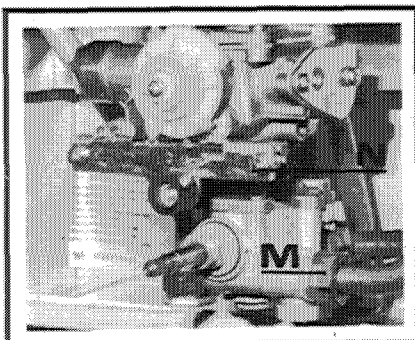

Fig. 13

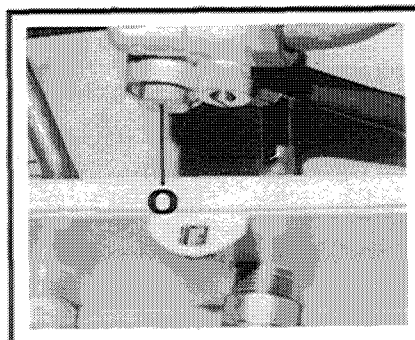

Fig. 14

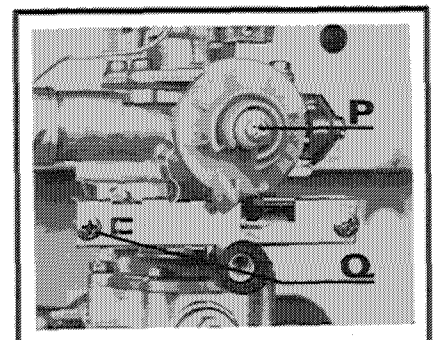

Fig. 15

FAULT FINDING CHART FOR CORVEC BRITONY II

PROBLEM	CAUSE	REMEDY
WATER TEMPERATURE	<ul style="list-style-type: none"> <li>i) Water rate too high (LP model)</li> <li>ii) Insufficient gas flow</li> <li>iii) Water governor sticking (Mains model)</li> <li>iv) Incorrect venturi</li> <li>v) No venturi fitted</li> </ul>	<ul style="list-style-type: none"> <li>Check water regulator</li> <li>Check rate and user's tap is open</li> <li>Remove and clean or replace</li> <li>Replace (Mains model 3.65 mm LP model)</li> <li>Fit</li> </ul>
BURNER STAYS ON	<ul style="list-style-type: none"> <li>i) Air in pipework</li> <li>ii) Gas valve stays open</li> <li>iii) Venturi blocked</li> <li>iv) Dirt on gas valve facing</li> <li>v) Loose jumper on house stop cock tap</li> <li>vi) Dirt or foreign matter in water section</li> </ul>	<ul style="list-style-type: none"> <li>Check for "dead-legs"</li> <li>Clean and grease gas spindle</li> <li>Remove and clean</li> <li>Strip and clean gas valve</li> <li>Replace water stop tap or pin down jumper</li> <li>Clean water section</li> </ul>
YELLOW FLAMES SOOT FORMED	<ul style="list-style-type: none"> <li>i) Heating body fins blocked</li> <li>ii) Primary air supply restricted</li> <li>iii) Wrong injectors</li> </ul>	<ul style="list-style-type: none"> <li>Remove heating body and clean</li> <li>Check burner manifold and clean</li> <li>Check injector sizes</li> </ul>
UNSTABLE FLAMES	<ul style="list-style-type: none"> <li>i) Water in gas line</li> <li>ii) Faulty flue</li> </ul>	<ul style="list-style-type: none"> <li>Purge</li> <li>Check terminal position and flue ducts</li> </ul>
HEATING BODY NOISE	<ul style="list-style-type: none"> <li>i) Scale</li> <li>ii) Excessive gas</li> <li>iii) Insufficient water flow</li> </ul>	<ul style="list-style-type: none"> <li>Descale heating body</li> <li>Check gas pressure (see Page 3)</li> <li>see below</li> </ul>
INSUFFICIENT WATER FLOW	<ul style="list-style-type: none"> <li>i) Water service tap partly closed</li> <li>ii) Blocked venturi</li> <li>iii) Low water pressure</li> <li>iv) Water governor faulty</li> <li>v) Water governor sticking</li> <li>vi) Foreign matter in water section</li> <li>vii) Water regulator (LP model)</li> </ul>	<ul style="list-style-type: none"> <li>Check it is fully opened</li> <li>Remove and clean venturi</li> <li>Check water pressure</li> <li>Change governor</li> <li>Remove and clean or replace</li> <li>Remove and clean</li> <li>Adjust</li> </ul>

**FAULT FINDING CHART FOR CORVEC BRITONY II**

<b>PROBLEM</b>	<b>CAUSE</b>	<b>REMEDY</b>
<b>PILOT FLAME DOES NOT LIGHT</b>	<ul style="list-style-type: none"> <li>i) Gas service tap closed</li> <li>ii) Air in pipe</li> <li>iii) Pilot injector blocked</li> <li>iv) No ignition spark</li> </ul>	<ul style="list-style-type: none"> <li>Open service tap</li> <li>Purge line</li> <li>Clean or change</li> <li>Check electrode, lead and ignitor</li> </ul>
<b>POOR PILOT FLAME</b>	<ul style="list-style-type: none"> <li>i) Pilot injector dirty/damaged</li> <li>ii) Wrong injector</li> <li>iii) Pilot head blocked</li> <li>iv) Faulty pilot tube</li> </ul>	<ul style="list-style-type: none"> <li>Clean or change</li> <li>Change for correct diameter (0.23 mm)</li> <li>Clean</li> <li>Clean or replace</li> </ul>
<b>PILOT WILL NOT STAY ALIGHT</b>	<ul style="list-style-type: none"> <li>i) Thermocouple not working</li> <li>ii) Thermo-electric valve faulty</li> <li>iii) Gas pressure low/variable</li> <li>iv) Terminal wrongly positioned</li> <li>v) Badly assembled flue</li> <li>vi) Gas pressure too high</li> </ul>	<ul style="list-style-type: none"> <li>Change thermocouple</li> <li>Change valve</li> <li>Check at inlet to heater (see Page 3)</li> <li>Re-position heater (see Page 3)</li> <li>Refit - check sealing</li> <li>Check with British Gas</li> </ul>
<b>MAIN BURNER DOES NOT LIGHT</b>	<ul style="list-style-type: none"> <li>i) Gas service tap not open fully</li> <li>ii) Gas pressure low</li> <li>iii) Water rate low</li> <li>iv) Gas valve not opening</li> <li>v) Diaphragm punctured</li> <li>vi) Venturi blocked or loose</li> <li>vii) Gas control tap faulty</li> <li>viii) Wrong injector</li> </ul>	<ul style="list-style-type: none"> <li>Open fully</li> <li>Check at manifold and at inlet with heater running (see Page 3)</li> <li>Check if water rate is sufficient (Page 3)</li> <li>Check (v) and (vi)</li> <li>Change diaphragm</li> <li>Check venturi</li> <li>Check operation of User's gas control tap</li> <li>Check for correct diameter (1.13 mm)</li> </ul>
<b>EXPLOSIVE IGNITION</b>	<ul style="list-style-type: none"> <li>i) Pilot</li> </ul>	<ul style="list-style-type: none"> <li>Check pilot tube and injector</li> </ul>
<b>GAS CONTROL TAP STIFF (USER'S)</b>	<ul style="list-style-type: none"> <li>i) Grease dried</li> <li>ii) Operating mechanism replaced incorrectly</li> </ul>	<ul style="list-style-type: none"> <li>Clean and regrease</li> <li>Refit</li> </ul>

---

CHAFFOTEAUX LIMITED  
Concord House . Brighton Road  
Salfords - Redhill  
SURREY RH1 5 DX  
HORLEY (02934) 72744

ESP008

Imp. Chaffoteaux et Maury  
Réf. 220.113 - 8/79