



EZ-FIT FLUE GUIDE

Universal flue systems to suit all Grant Vortex and VortexBlue condensing oil boiler ranges. Also includes the latest black painted flues!

CE Fully compliant with the latest legislation



Round **Low Level** balanced flue systems stainless steel - black painted terminal

Yellow System Low Level Balanced EZ-Fit flue kits

The Grant low level balanced flue range has been developed to make the installation of Grant Vortex and VortexBlue boilers both quick and simple, whilst ensuring trouble free operation even in the most exposed site conditions.

Reduces installation time

The round low level kits feature self-sealing ducts requiring no silicone or tape for joints, and the unique quick-fit connection arrangement ensures a perfect seal every time. In fact, the telescopic flue system requires only two simple operations to complete the installation. The kits are compatible with all Grant boilers, except external modules.

The Grant flue terminal

The flue terminal has a compact design and is available in a black painted finish, making it ideal for installations where the visual appearance is important. The design reduces the possibility of condensate, produced in the combustion process, staining external wall surfaces or patio slabs.

316 Stainless Steel

Low Level balanced flue hole cutting dimensions				
Model	Dimensions (mm)			
	A dia	B	C	D
Vortex Pro 15/21 & 15/26	127	115	768	n/a
Vortex Eco 15/21 & 21/26	127	115	768	n/a
Vortex Pro 26/36 & 36/46	162	115	780	n/a
Vortex Eco 26/35	162	115	780	n/a
Vortex Pro 46/58 & 58/70	162	112	1105	n/a
Vortex Pro Combi 21e & 26e	127	115	768	n/a
Vortex Pro Combi 36e	162	105	780	n/a
Vortex Eco Wall Hung 12/16 & 16/21	127	112	H + 765*	220
Vortex Boiler House 15/21 & 21/26	127	120	768	n/a
Vortex Boiler House 26/35 & 36/46	162	120	780	n/a
Vortex Boiler House 46/58 & 58/70	162	120	1102	n/a

Note: *H is the height (mm) from floor to underside of boiler casing.

Note: Flue diameters 123mm 152mm

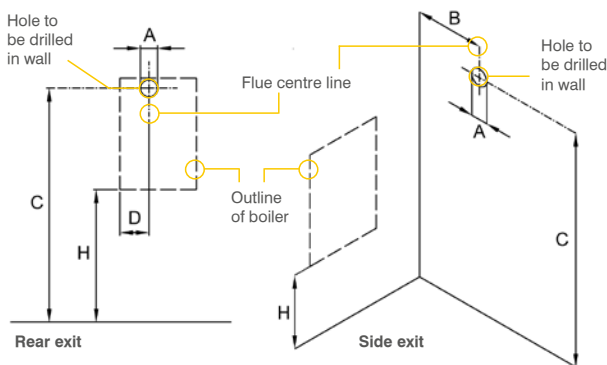

Note: Dimension 'B' is given with the boiler pushed back against the rear wall. Any clearances must be added to 'B'. Dimension 'A' includes an extra 10mm over the size of the terminal to provide clearance for fitting.

Extensions

The flue kits are telescopic and available in short or standard options. For wall thicknesses greater than shown, three extensions are available which extend the flue by 225mm, 450mm or 675mm to a maximum of four metres. 90° and 45° elbows are also available to give a greater degree of flexibility when siting the boiler.

Plume diverter kits (Black painted)

Grant has developed a solution for existing low level flues where plumbing causes a nuisance. The new plume diverter kits are designed to fit with our latest EZ-Fit Yellow low level balanced flue system. The kit comprises a starter elbow, which fits over the already fitted flue terminal, 2 x 1m lengths of stainless steel flue pipe, a terminal elbow together with 2 x adjustable brackets. It is available in 80mm diameter for boilers up to 26kW and 100mm diameter for boilers from 26-70kW.

Low Level flue kit

with 90° elbow extension added (black painted terminal section)

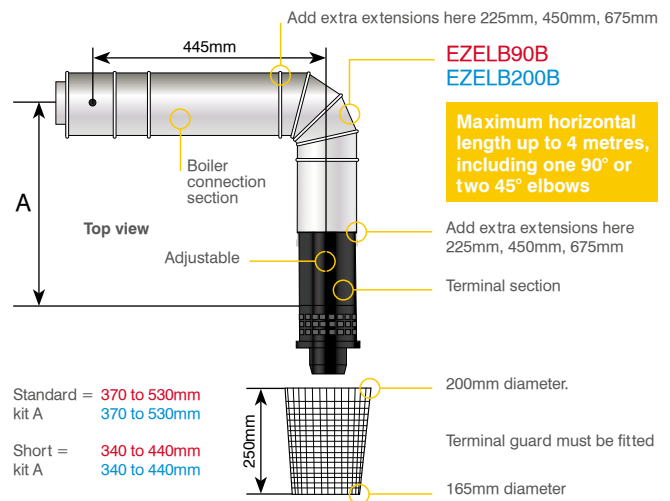

Standard = 370 to 530mm
kit A = 370 to 530mm
Short = 340 to 440mm
kit A = 340 to 440mm

Low Level flue kit

(black painted terminal section)

Standard flue kit (black): EZ90B / EZ200B
Short flue kit (black): EZ90SB / EZ200SB

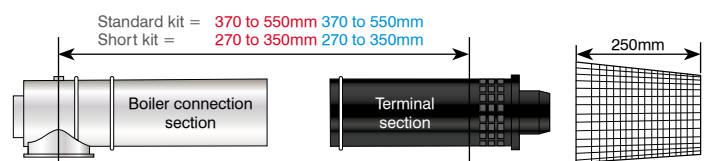

Contents of Low Level flue kit:

Boiler connector section
Terminal section
Flue guard
Dress plate (not shown)
Plugs and screws
Side outlet cover trim (not shown)
Lubricant (not shown)
Snorkel clamp (not shown)

Low Level balanced flue kits

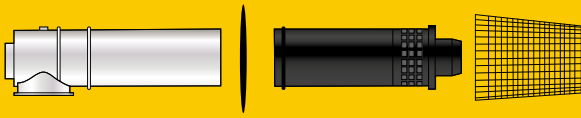

Standard flue kit (Black Painted Finish)

EZ90B	Models up to 26kW
EZ200B	Models 26 - 70kW

Short flue kit (Black Painted Finish)

EZ90SB	Models up to 26kW
EZ200SB	Models 26 - 70kW

Low Level balanced flue extensions

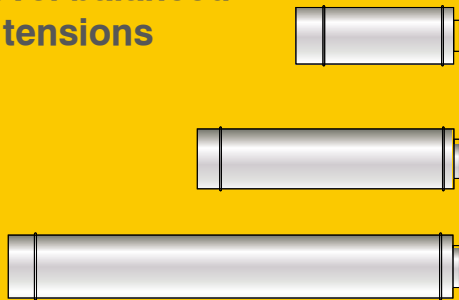

Extension 225mm

X90S	Models up to 26kW
X200S	Models 26 - 70kW

Extension 450mm

X90M	Models up to 26kW
X200M	Models 26 - 70kW

Extension 675mm

X90L	Models up to 26kW
X200L	Models 26 - 70kW

Important

Flue extensions cannot be cut. Yellow system extensions are for horizontal use only and cannot be used vertically with Green, Orange, Red or White system components.

Low Level balanced flue accessories

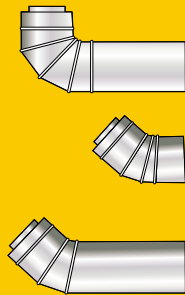

90° elbow kit

EZELB90	Models up to 26kW
EZELB200	Models 26 - 70kW

45° elbow only

EZ45/90S	Models up to 26kW
EZ45/200S	Models 26 - 70kW

45° elbow kit

EZ45/90	Models up to 26kW
EZ45/200	Models 26 - 70kW

Important

Horizontal lengths up to 4 metres can be accommodated, including one 90° or two 45° elbows.

Offset elbows

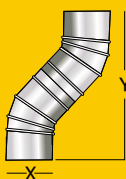

45° elbows can be used with Low Level kits to offset the flue. Extensions can be used between elbows.

Elbows directly connected

Code	X	Y
EZ45/90S	120	260
EZ45/200S	130	280

Important

Extended elbows allow telescopic adjustment for extensions or terminal sections.

Plume diverter kits and accessories



Plume diverter kit

GPDA90B	Models up to 26kW
GPDA200B	Models 26 - 70kW

Extension 250mm

GPD250EXT/90B	Models up to 26kW
GPD250EXT/200B	Models 26 - 70kW

Extension 500mm

GPD500EXT/90B	Models up to 26kW
GPD500EXT/200B	Models 26 - 70kW

Extension 1000mm

GPD1000EXT/90B	Models up to 26kW
GPD1000EXT/200B	Models 26 - 70kW

Important

Maximum height for a plume diverter kit is 6 metres. Deduct 500mm for each 45° elbow used.

Please note that the plume diverter kits are not compatible with Vortex external modules.

45° elbow

GPDA45/90B	Models up to 26kW
GPDA45/200B	Models 26 - 70kW

Wall bracket

GPDBRK T90B	Models up to 26kW
GPDBRK T200B	Models 26 - 70kW

Internal **High Level** balanced flue systems - white powder coated

White System High Level Balanced EZ-Fit flue kits

High level balanced flue kits feature the same boiler connections as the low level flue. The unique connection system on the high level flue ensures easy assembly thereby reducing installation costs.

Flexible design

The kits may be extended horizontally and vertically. It is now possible to create offsets in standard high level flue systems by using our 45° elbows and extension kits – increasing the versatility of this range.

Maximum flue length

High Level balanced flues can be extended to a **maximum of 10 metres overall**, using the extension kits illustrated on page 5. Deduct one metre for each additional 45° elbow used (maximum 6 elbows).

316 Stainless Steel

High level balanced flue hole cutting dimensions						
Model	Dimensions (mm)					
	A dia	B	C min	D min	D max	E
Vortex Pro 15/21 & 15/26	175	115	1225	1740	2130	n/a
Vortex Eco 15/21 & 21/26	175	115	1225	1740	2130	n/a
Vortex Pro 26/36 & 36/46	200	115	1275	1710	2010	n/a
Vortex Eco 26/35	200	115	1275	1710	2010	n/a
Vortex Pro 46/58 & 58/70	200	112	1600	2035	2335	n/a
Vortex Pro Combi 21e & 26e	175	115	1225	1740	2130	n/a
Vortex Pro Combi 36e	200	115	1275	1710	2010	n/a
Vortex Eco Wall Hung 12/16 & 16/21	200	112	H+1217*	H+1732*	H+2122*	220
Vortex Boiler House 15/21 & 21/26	175	200	1215	1715	2115	n/a
Vortex Boiler House 26/35 & 36/46	200	200	1280	1700	2020	n/a
Vortex Boiler House 46/58 & 58/70	200	200	1595	2015	2335	n/a

Note: *H is the height (mm) from floor to underside of boiler casing.

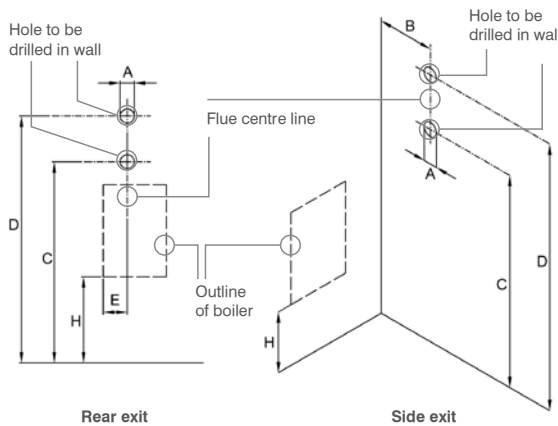

Note: Flue pipe diameter: 150mm 180mm excluding locking bands (see dimension 'A' opposite for hole size).

Dimensions

Section 'B' is the starter piece for the flue system and fits into the boiler connector supplied with the kit. Section 'B' incorporates the air supply spigot and a combustion test point. Sections 'C' and 'D' combine to form a telescopic length. Terminal section 'F' slides over elbow 'E'. The horizontal length can be extended using the extensions listed. The adjustable extension cannot be connected to the terminal section 'F' – a fixed extension must be used. The vertical height can be extended using the extensions or 45° elbows listed. For short heights sections 'C' and 'D' may be omitted and elbow 'E' fitted to starter section 'B'.

Top casing height = X	
Model	Dimensions (mm)
Vortex Pro 15/21 & 15/26	170
Vortex Eco 15/21 & 21/26	170
Vortex Pro 26/36 & 36/46	205
Vortex Eco 26/35	205
Vortex Pro 46/58 & 58/70	225
Vortex Pro Combi 21e & 26e	170
Vortex Pro Combi 36e	205
Vortex Eco Wall Hung 12/16 & 16/21	165

Internal High Level flue kit (white powder coated)

HL K01 50/90
HL K02 90/200

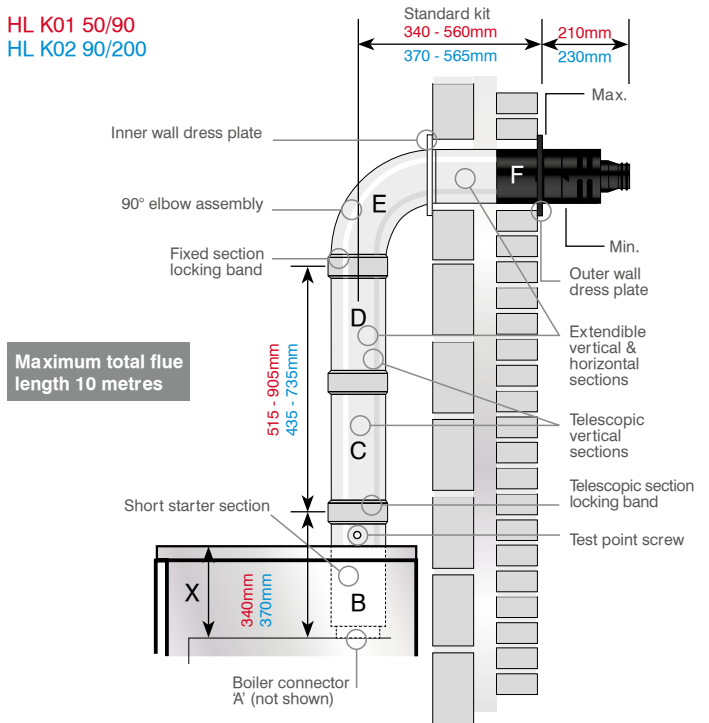

Contents of High Level balanced flue kit:

- Boiler connector A
- Short starter section B
- Vertical telescopic section C/D
- Horizontal telescopic section (inc. terminal) E/F
- Locking bands
- Inner seals (red)
- Outer seal (black)
- Boiler connector
- Dress plates (inner & outer)
- Fitting Instructions

Note: For height adjustment see chart left.

Internal High Level balanced flue kits

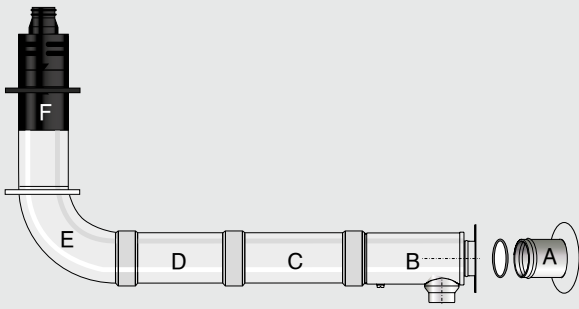

1.2 metre High Level flue kit	
HL K01 50/90	Models up to 26kW
HL K02 90/200	Models 26 - 70kW

Important

If the terminal section executes below two metres, a terminal guard must be fitted.

A terminal guard is required when the flue terminates less than 2 metres above outside ground level (not supplied as standard).

Internal High Level balanced flue kits

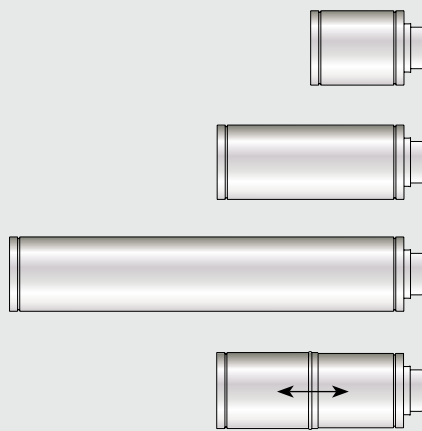

Extension 225mm C/W locking band	
EXT K31 225/90	Models up to 26kW
EXT K32 225/200	Models 26 - 70kW

Extension 450mm C/W locking band	
EXT K09 450/90	Models up to 26kW
EXT K10 450/200	Models 26 - 70kW

Extension 950mm C/W locking band	
EXT K11 950/90	Models up to 26kW
EXT K12 950/200	Models 26 - 70kW

Adjustable extension 275-450mm C/W locking band	
EXT K13 ADJ/90	Models up to 26kW
EXT K14 ADJ/200	Models 26 - 70kW

Important

Flue extensions cannot be cut. White system extensions are for High Level, Vertical and Red system Internal use only and cannot be used with Yellow, Green or Orange system components.

Important

We recommend an additional wall bracket for every 1 metre of flue extension.

High Level balanced flue accessories



45° Elbow C/W locking band	
ELB K21 45/90	Models up to 26kW
ELB K22 45/200	Models 26 - 70kW



Wall bracket	
BRK 29 90	Models up to 26kW
BRK 30 200	Models 26 - 70kW

Important

High Level balanced flues can be extended to a maximum length of 10 metres using the extension kits illustrated above. Deduct one metre for each additional 45° elbow used (maximum 6 elbows). We recommend an additional wall bracket for every 1 metre of flue extension.

Offset elbows

45° elbows can be used with High Level kits to offset the flue. Extensions can be used between elbows.

Elbows directly connected

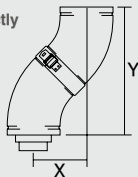

Elbows connected via fixed extensions

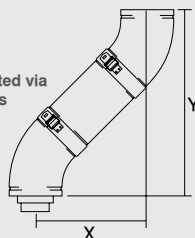

Elbows connected via adjustable extension

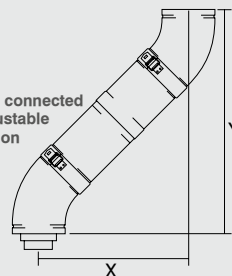

Code	X	Y
ELB K21	140	340
ELB K22	160	385

Code	Extension	X	Y
ELB K21	EXT225	300	500
	EXT450	455	665
	EXT950	810	1010
ELB K22	EXT225	320	545
	EXT450	475	700
	EXT950	830	1055

Code	X	Y
ELB K21	335-455	535-655
ELB K22	355-475	580-700

Important

A terminal guard is required when the flue terminates less than 2 metres above outside ground level (not supplied as standard).

*Internal High Level balanced flue systems are compatible with all Grant boilers, with the exception of the external modules.

White System Vertical Balanced EZ-Fit flue kits

Vertical balanced flue kits share the same boiler connections as our high level kits. The unique connection system on the vertical balanced flue ensures easy assembly thereby reducing installation costs.

Flexible design

As with our high level kits it is now possible to create offsets in straight flue runs by using our 45° elbows and adjustable extension kits – increasing the versatility of this range.

Maximum Vertical flue length

Vertical balanced flues can be extended to a maximum length of 12 metres in a straight run using the extension kits illustrated on page 7. Deduct one metre for each additional 45° elbow used (maximum 6 elbows).

Dimensions

The dimensions shown are measured from the top of the boiler spigot, not the boiler case. The distance between the boiler flue spigot and the top of the casing should be taken into consideration (See boiler installation manual).

Section (A) is the starter piece for the flue system and push fits into the boiler connector supplied with the kit. Section (B) incorporates the air supply spigot and a combustion test point.

Sections (C) and (D) combine to form a telescopic length. Fixed extension (E) fits onto telescopic section (D). Terminal section (F) fits onto fixed extension (E).

For short flue heights section (E) may be omitted and the terminal section (F) may be fitted directly to section (D). The terminal section (F) overlaps section (D) by 50mm.

Terminal extension

A new extended black terminal section for the vertical flue systems is now available, which extends the flue extract section by a further one metre (VTTEXT90 / VTTEXT200).

This kit is useful, if for instance, there is a roof window or opening too close to the terminal.

Vertical flue kit (white powder coated)

VT K05 50/90
VT K06 90/200

Note: Flue pipe diameter: 150mm 180mm
Excluding locking bands

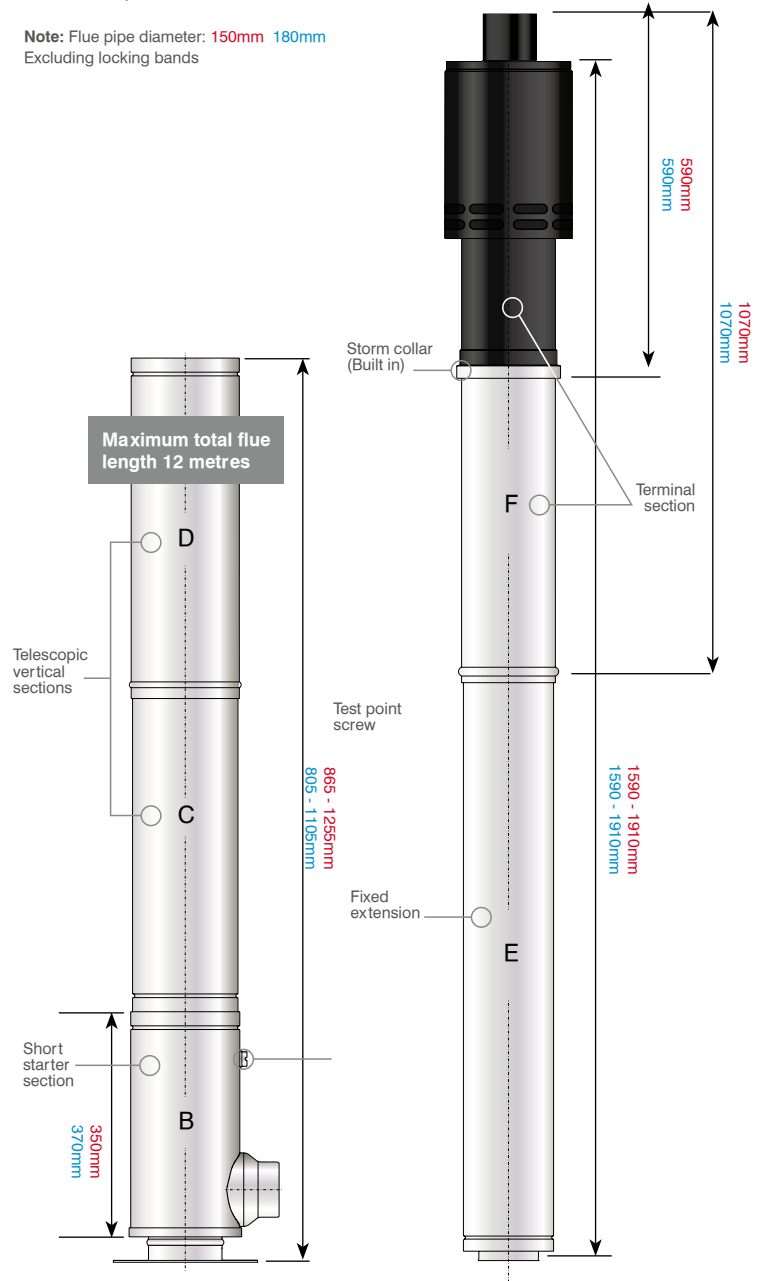

Quick fit connection

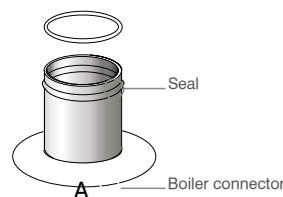

Contents of 3 metre balanced flue kit:

- Boiler connector A
- Short starter section B
- Telescopic vertical sections C/D
- Fixed section 950mm E
- Terminal section F (inc. storm collar)
- Locking bands (not shown)
- Inner seals (red)
- Ceiling dress plate (not shown)
- Firestop spacers (not shown)
- Wall bracket
- Fitting Instructions

Internal Vertical balanced flue kits

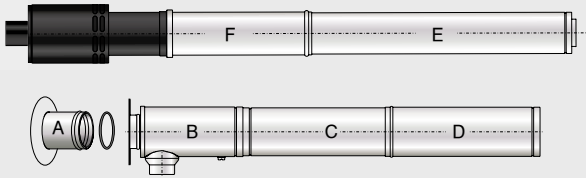

3 metre Vertical flue kit	
VT K05 50/90	Models up to 26kW
VT K06 90/200	Models 26 - 70kW

Internal Vertical balanced flue extensions

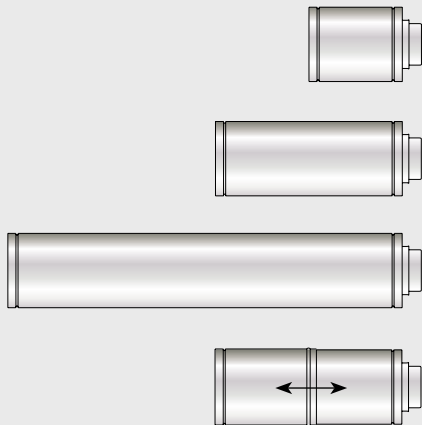

Extension 225mm c/w locking band	
EXT K31 225/90	Models up to 26kW
EXT K32 225/200	Models 26 - 70kW
Extension 450mm c/w locking band	
EXT K09 450/90	Models up to 26kW
EXT K10 450/200	Models 26 - 70kW
Extension 950mm c/w locking band	
EXT K11 950/90	Models up to 26kW
EXT K12 950/200	Models 26 - 70kW
Adjustable extension 275-450mm c/w locking band	
EXT K13 ADJ/90	Models up to 26kW
EXT K14 ADJ/200	Models 26 - 70kW

Important

Flue extensions cannot be cut. White system extensions are for High Level, Vertical and Red system Internal use only and cannot be used with Yellow, Green or Orange system components.

Important

We recommend an additional wall bracket for every 1 metre of flue extension.

Vertical balanced flue accessories

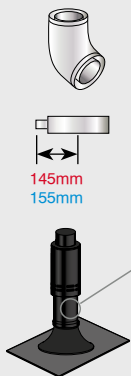

45° Elbow c/w locking band	
ELB K21 45/90	Models up to 26kW
ELB K22 45/200	Models 26 - 70kW
Wall bracket (white powder coated)	
BRK 29 90	Models up to 26kW
BRK 30 200	Models 26 - 70kW
Flat roof flashing - aluminium	
VT K27 F90	Models up to 26kW
VT K28 F200	Models 26 - 70kW
Pitched roof flashing – aluminium	
VT MF 90/200	All models

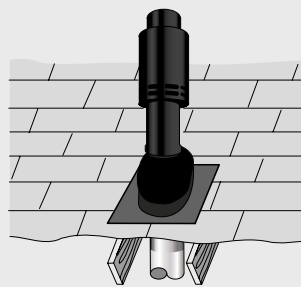

Note: Range of pitch 22°-45°.

Pitched roof flashing – lead (with collar)	
VT K25 P90	Models up to 26kW
Pitched roof flashing – lead (no collar)	
VT K26 P240	Models up to 70kW
Pitched roof flashing – lead replacement (with collar)	
VT K26 P200/X	Models 26 - 70kW
Vertical terminal extension	
VTTEXT90	Models up to 26kW
VTTEXT200	Models 26 - 70kW

Offset elbows

45° elbows can be used with High Level kits to offset the flue. Extensions can be used between elbows.

Elbows directly connected

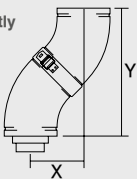

Elbows connected via fixed extensions

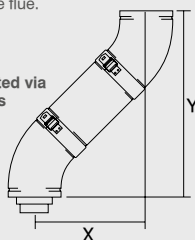

Elbows connected via adjustable extension

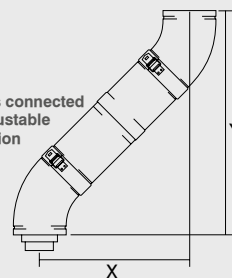

Code	X	Y
ELB K21	140	340
ELB K22	160	385

Code	Extension	X	Y
ELB K21	EXT225	300	500
	EXT450	455	665
	EXT950	810	1010
ELB K22	EXT225	320	545
	EXT450	475	700
	EXT950	830	1055

Code	X	Y
ELB K21	335-455	535-655
ELB K22	355-475	580-700

Red System Flexi Vertical balanced EZ-Fit flue kits

The Grant Red system is a unique flexible balanced flue solution to nuisance plumbing and cold draughts. It is designed for Grant Vortex condensing boilers up to 26kW (90,000Btu/h) and allows an existing masonry chimney to be utilised rather than re-site the boiler and pipework.

Red System kits

The Grant Red System is supplied in a pack consisting of two lengths of stainless steel flexible vertical flue pipe (available in lengths for 6, 8, 10 and 12 metres), a rigid/flex adaptor, telescopic flue (upper and lower), support clamp, locking band, starter section, boiler connector, fixings and screws and a tube of mastik.

Extensions and elbows (from White System)

The flexible vertical balanced flue kits share the same EZ-Fit flue extensions and elbows as the Grant White system. This unique quick fit connection arrangement ensures easy assembly thereby reducing installation costs.

The maximum vertical straight length of the flue, from the top of the boiler to the top of the terminal, is 20 metres – using no more than four 45° elbows.

One metre of straight flue length should be deducted for every elbow used. If the flexible liner has to pass around an offset inside the chimney, two metres of straight flue length should be deducted to compensate for this i.e. equivalent two 45° elbows.

Flue extensions cannot be cut, adjustable extensions should be used where required.

Maximum straight flue length from the boiler to the top of flue terminal = 20 metres.

Note: Flexi flue pipe diameter:
Inner diameter - 80mm
Outer diameter - 125mm

Important

The Red System shares extension pieces and elbows from the White system.

Optional extras (from White System)

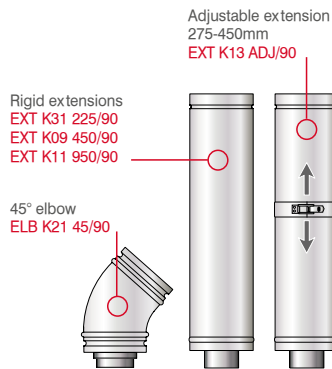

Rigid to flexible balanced flue

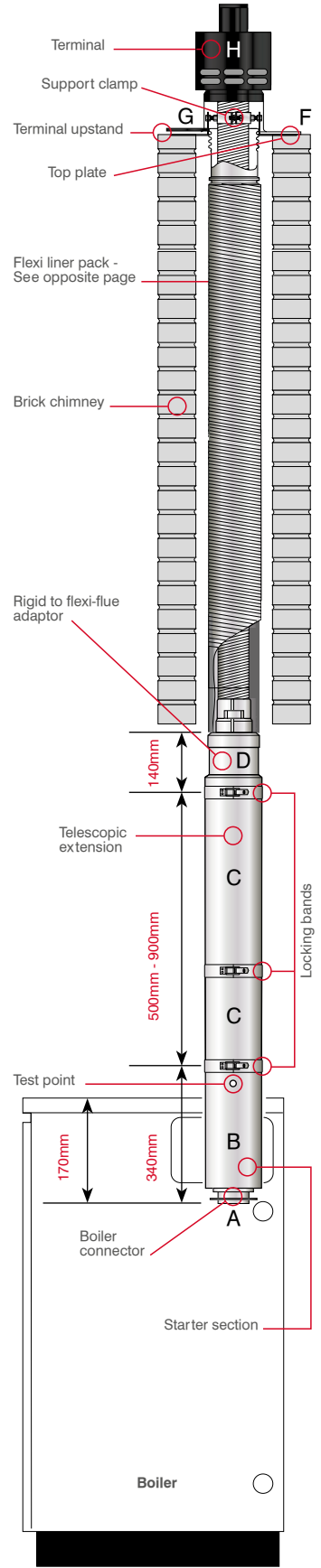

316 Stainless Steel

Offset elbows

45° elbows can be used with High Level kits to offset the flue. Extensions can be used between elbows.

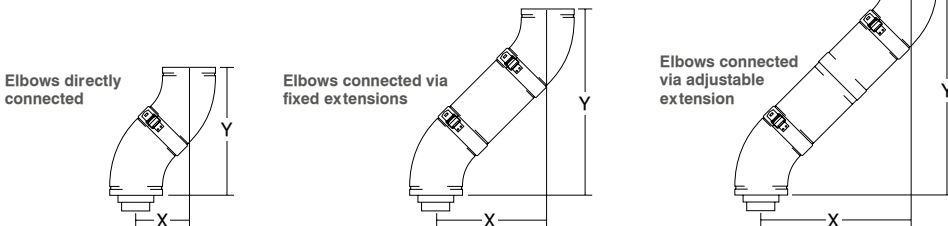

Code	X	Y
ELB K21	140	340

Code	Extension	X	Y
ELB K21	EXT225	300	500
	EXT450	455	665
	EXT950	810	1010

Code	Extension	X	Y
ELB K21	EXTADJ	335-455	535-655

Flexi Vertical balanced flue pack with liner

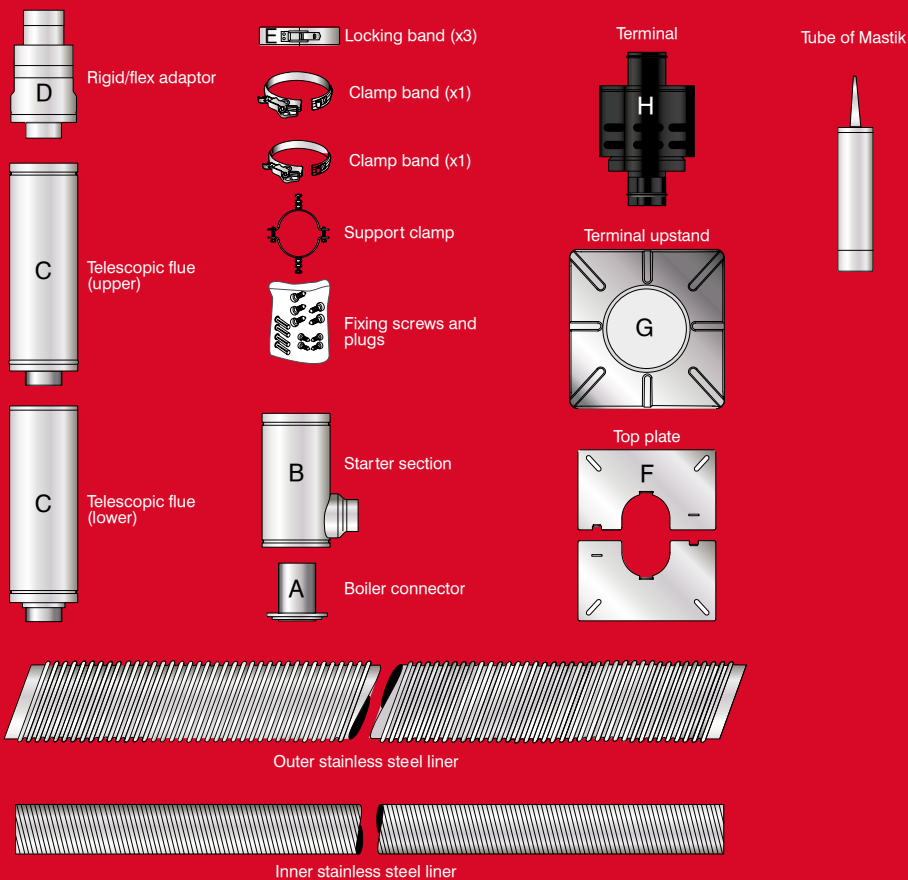

6 metre Flexible flue liner pack
GFX BF 6/26 COMR Models up to 26kW

8 metre Flexible flue liner pack
GFX BF 8/26 COMR Models up to 26kW

10 metre Flexible flue liner pack
GFX BF 10/26 COMR Models up to 26kW

12 metre Flexible flue liner pack
GFX BF 12/26 COMR Models up to 26kW

Note: Longer Flexi balanced flue liner kits are available by special order. Liners are directional and should be installed with the arrows facing upwards.

Rigid flue extensions & elbows (from White System)

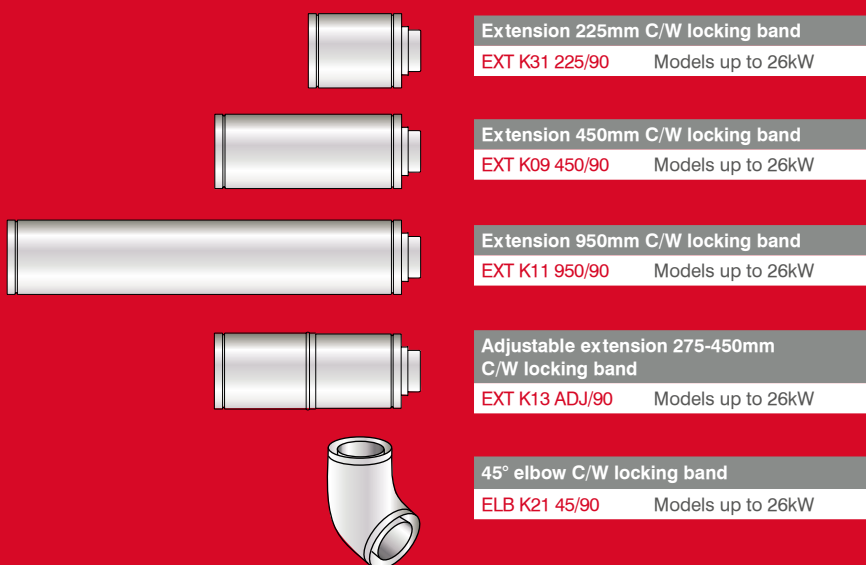

Important

Flue extensions cannot be cut. White system extensions are for High Level, Vertical and Red system Internal use only and cannot be used with Yellow, Green or Orange system components.

External High Level/Vertical flues - black painted

Green System External High Level/Vertical EZ-Fit flue kits

External high level and vertical flue systems are supplied in a modular form enabling most installations to be accommodated and are manufactured from high grade stainless steel.

Starter flue kits (Plume diverter)

The starter flue kit enables all internal boilers to be connected to an external high level or vertical flue system, whilst maintaining the room sealed operation of the boiler.

It is even possible to convert an existing EZ-Fit low level balanced flue kit to an external high level or vertical arrangement without any additional building work. This is particularly useful when plumbing from a low level flue terminal is a nuisance.

316 Stainless Steel

External high level flue hole cutting dimensions

Model	Dimensions (mm)		
	A dia	B	C
Vortex Pro 15/21 & 15/26	127	115	768
Vortex Eco 15/21 & 21/26	127	115	768
Vortex Pro 26/36 & 36/46	162	115	780
Vortex Eco 26/35	162	115	780
Vortex Pro 46/58 & 58/70	162	112	1102
Vortex Pro Combi 21e & 26e	127	115	768
Vortex Pro Combi 36e	162	105	780
Vortex Eco Wall Hung 12/16 & 16/21	127	112	H + 765*
Vortex Pro Boiler House 26/35 & 36/46	162	115	780
Vortex Pro Boiler House 46/58 & 58/70	162	115	780

Note: *H is the height (mm) from floor to underside of boiler casing.

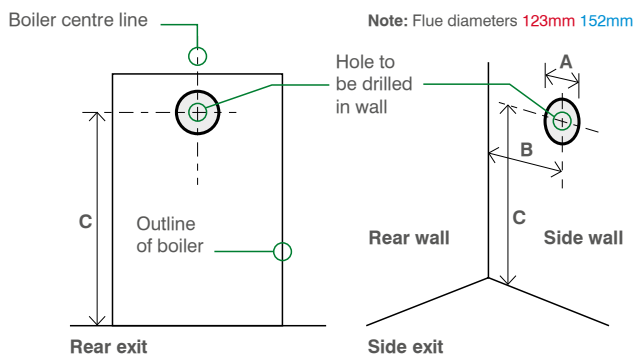

Note: Dimension 'B' is given with the boiler pushed back against the rear wall. Any clearances must be added to 'B'.

External flue system

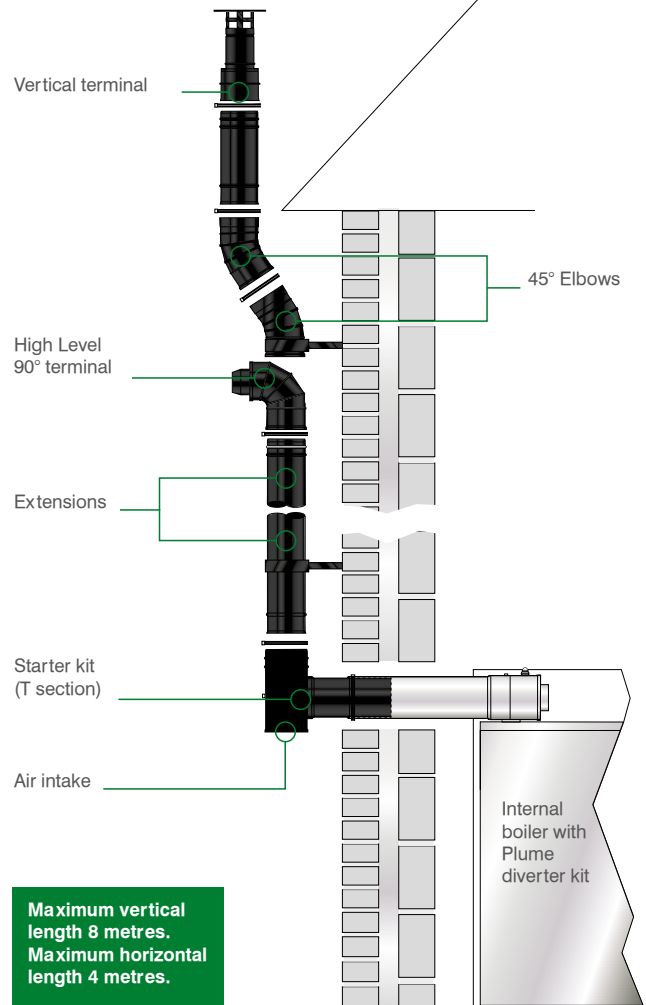

Offset elbows

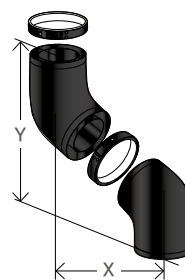

Code	X	Y
GE45/90B	126	304
GE45/200B	142	343

45° elbows can be used with high level flues to create off-sets. Extensions can be used between elbows.

Low Level starter kits

Standard kit =
370 to 550mm 370 to 550mm

Short kit =
270 to 350mm 270 to 350mm

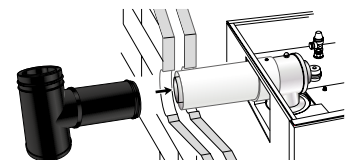

Contents of Low Level starter kit:

- Boiler connector section
- Tee section
- Side outlet cover trim
- Snorkel clamp (not shown)
- Dress plate
- Fixing clamp and gasket
- Lubricant (not shown)

External High Level/Vertical starter flue kit

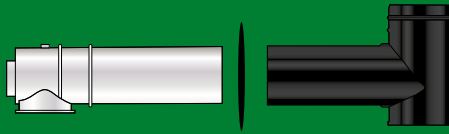

Standard flue kit	
GK90B	Models up to 26kW
GK200B	Models 26 - 70kW

Short flue kit	
GK90SB	Models up to 26kW
GK200SB	Models 26 - 70kW

Important

Starter flue kits can be extended horizontally using extensions or elbows from the Low Level balanced flue, Yellow system only. See page 3.



Extension 150mm c/w locking band	
GX150/90B	Models up to 26kW
GX150/200B	Models 26 - 70kW

Extension 250mm c/w locking band	
GX250/90B	Models up to 26kW
GX250/200B	Models 26 - 70kW

Extension 450mm c/w locking band	
GX450/90B	Models up to 26kW
GX450/200B	Models 26 - 70kW

Extension 950mm c/w locking band	
GX950/90B	Models up to 26kW
GX950/200B	Models 26 - 70kW

Adjustable extension 195-270mm c/w locking band	
GXA250/90B	Models up to 26kW
GXA250/200B	Models 26 - 70kW

Important

Flue extensions cannot be cut. Green system extensions are for horizontal or vertical use with conventional flue systems only and cannot be used with Yellow or White balanced flue components.

Stainless steel terminals

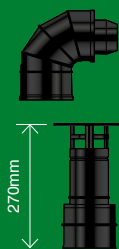

High Level 90° terminal	
GTH90B	Models up to 26kW
GTH200B	Models 26 - 70kW

Vertical terminal	
GTV90B	Models up to 26kW
GTV200B	Models 26 - 70kW

Important

Extension lengths given are effective lengths i.e. when fitted in a flue system.

Stainless steel

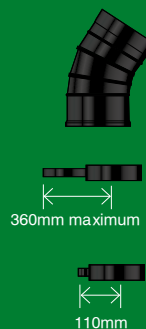

45° elbow c/w locking band	
GE45/90B	Models up to 26kW
GE45/200B	Models 26 - 70kW

Extended wall bracket	
GEB90B	Models up to 26kW
GEB200B	Models 26 - 70kW

Wall bracket	
GWB90B	Models up to 26kW
GWB200B	Models 26 - 70kW

Orange System Conventional EZ-Fit flue kits

As many older oil fired boilers are traditionally connected to conventional flue systems, updating to a modern condensing boiler often results in the appliance needing to be relocated.

The Grant EZ-Fit conventional flue has been specifically designed for the Grant Vortex/VortexBlue boiler range to enable the existing chimney to be re-used and the appliance retained in its original position.

Flexi packs

There are a range of EZ-Fit flexi packs containing all the components required to utilise the existing chimney, including a smooth bore stainless steel flue liner, terminal, clamp plate and connectors for both the flex and boiler. All that is required to complete the installation is extension pipes or elbows from our Grant Orange system accessories range.

Please note: the flexi liner should be installed with the directional arrows pointing upwards only.

Pluming

Condensing boilers operate at extremely high efficiencies with cool flue gas temperatures, resulting in a plume of vapour being visible at the flue terminal. This pluming (steam) is a normal condition of condensing boilers and indicates that the appliance is working efficiently. As an alternative to a Low Level, High Level, or Vertical balanced flue kit, utilising the original chimney with a Grant conventional Flexi-pack moves the plume of vapour above roof level.

Combustion air and ventilation

An adequate permanent air supply is required for the safe operation of all open-flued (**conventional flued**) oil-fired appliances. For new or replacement boilers in properties built prior to the latest change to the Building Regulations (pre Approved Document L1A 2006) in England and Wales this ventilation must be in accordance with BS5410-1:2014. For installations in properties built or refurbished under the above current Building Regulations, the first 5kW of output should no longer be omitted for the purposes of calculating the ventilation area required.

316 Stainless Steel

Top casing height = X

Model	X dimensions (mm)
Vortex Pro 15/21 & 15/26	170
Vortex Eco 15/21 & 21/26	170
Vortex Pro 26/36 & 36/46	205
Vortex Eco 26/35	205
Vortex Pro 46-58 & 58/70	225
Vortex Pro Combi 21e & 26e	170
Vortex Pro Combi 36e	205
Vortex Eco Wall Hung 12/16 & 16/21	165

Optional extras

Rigid extensions

- WX 150/100
- WX 150/125
- WX 250/100
- WX 250/125
- WX 450/100
- WX 450/125
- WX 950/100
- WX 950/125

45° elbow

- WE 45/100
- WE 45/125

Adjustable extension

- 235-300mm
- WXA 250/100
- WXA 250/125

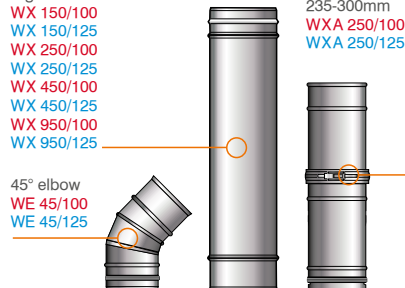

Rigid to Flexible Conventional flue system

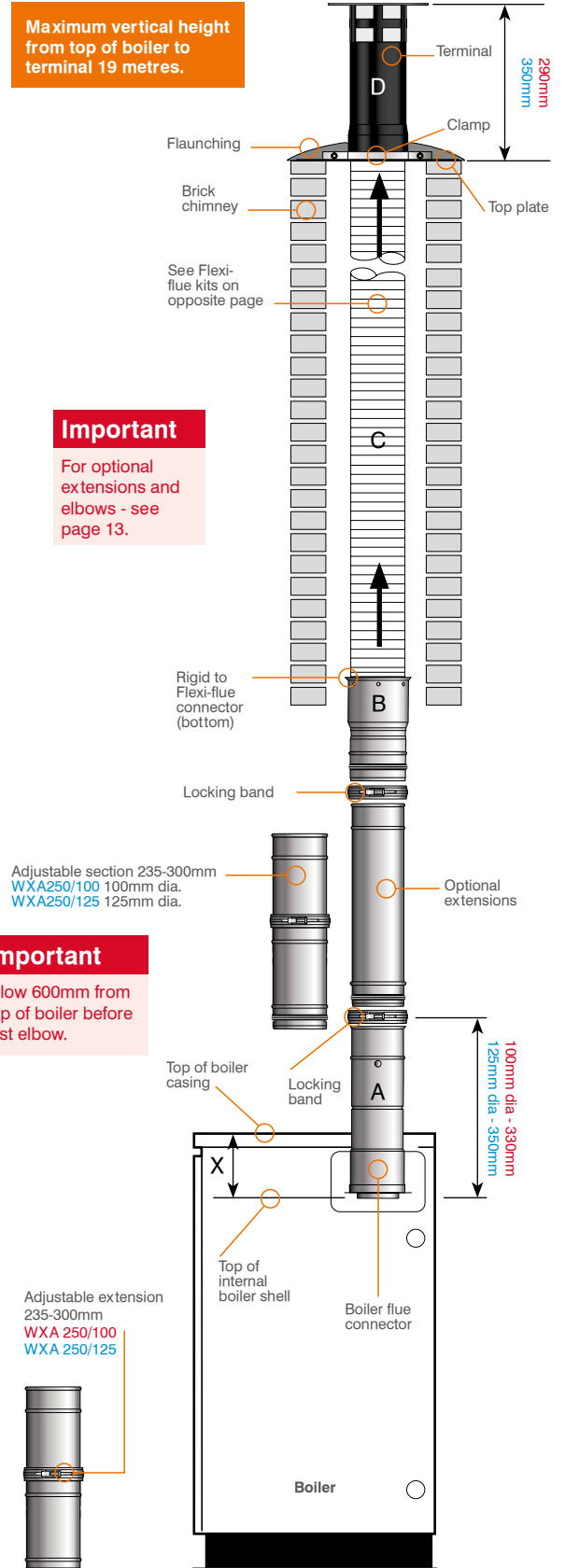

Smooth Bore Flexi-flue kits stainless steel

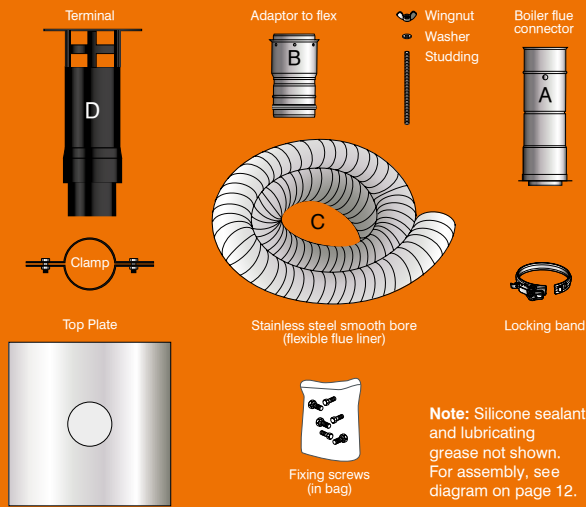

Note: Silicone sealant and lubricating grease not shown. For assembly, see diagram on page 12.

6 metre flexible flue kit

GF KIT 6/100	Models up to 46kW
GF KIT 6/125	Models 46 - 70kW

8 metre flexible flue kit

GF KIT 8/100	Models up to 46kW
GF KIT 8/125	Models 46 - 70kW

10 metre flexible flue kit

GF KIT 10/100	Models up to 46kW
GF KIT 10/125	Models 46 - 70kW

11 metre flexible flue kit

GF KIT 11/100	Models up to 46kW
GF KIT 11/125	Models 46 - 70kW

12 metre flexible flue kit

GF KIT 12/100	Models up to 46kW
GF KIT 12/125	Models 46 - 70kW

14 metre flexible flue kit

GF KIT 14/100	Models up to 46kW
GF KIT 14/125	Models 46 - 70kW

16 metre flexible flue kit

GF KIT 16/100	Models up to 46kW
GF KIT 16/125	Models 46 - 70kW

Flue extensions white powder coated (single skin)

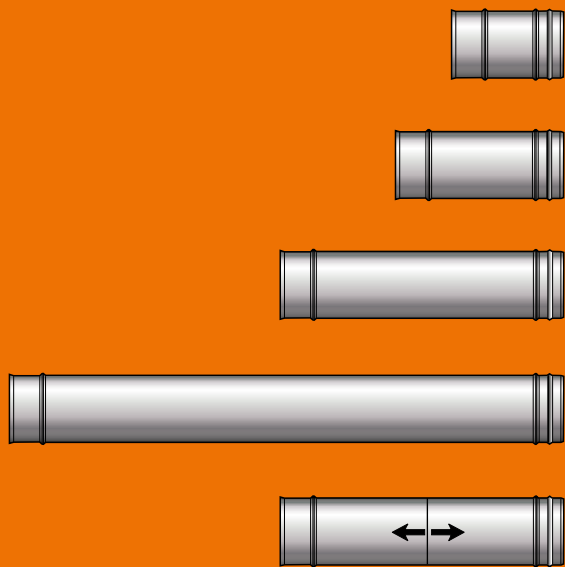

Extension 150mm c/w locking band

WX 150/100	Models up to 46kW
WX 150/125	Models 46 - 70kW

Extension 250mm c/w locking band

WX 250/100	Models up to 46kW
WX 250/125	Models 46 - 70kW

Extension 450mm c/w locking band

WX 450/100	Models up to 46kW
WX 450/125	Models 46 - 70kW

Extension 950mm c/w locking band

WX 950/100	Models up to 46kW
WX 950/125	Models 46 - 70kW

Adjustable extension 235-300mm c/w locking band

WXA250/100	Models up to 46kW
WXA250/125	Models 46 - 70kW

Important

Flue extensions cannot be cut. Orange system extensions are for vertical use only and cannot be used with Yellow or White system components.

Accessories white powder coated

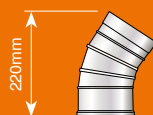

45° elbow c/w locking band

WE 45/100	Models up to 46kW
WE 45/125	Models 46 - 70kW

Important

Wherever possible incorporate one adjustable section. No more than two 45° elbows can be used.

Extension lengths given are effective lengths i.e. When fitted in a flue system.

Offset elbows

45° elbows can be used to offset the flue. Flue extensions can be used between elbows.



Code	X	Y
WE45/100	126	304
WE45/125	142	343

Hybrid Conventional flue systems - interconnecting flues

Hybrid Orange to Green flue system

Using components from the Grant Orange and Green flue systems it is possible to construct bespoke flue systems to overcome specific boiler siting problems.

See page 13 for white powder coated internal Orange system components and pages 11 & 15 for external Green system and adaptors.

For further information contact the Technical Department on 01380 736920.

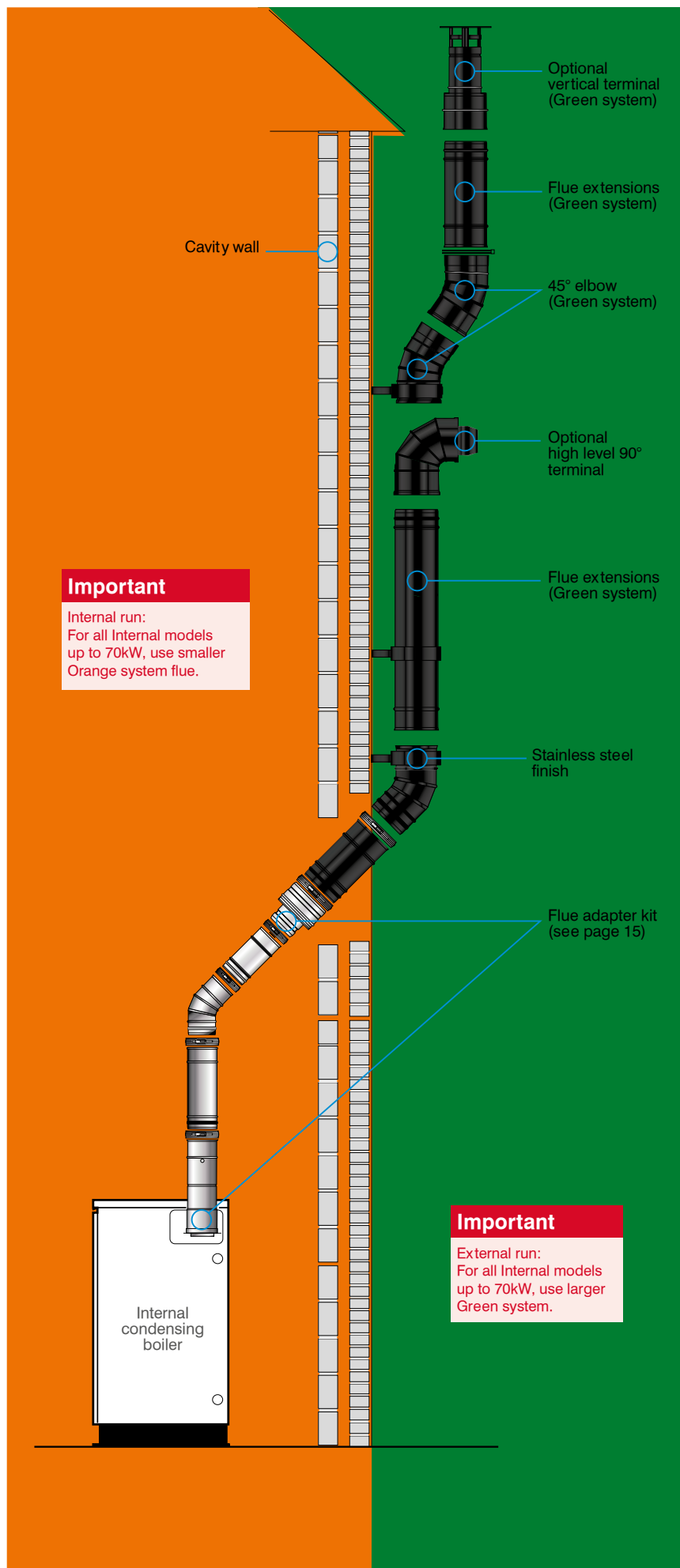

External Green system - Outdoor module (including wall hung)

Vertical solutions

See page 11 for extensions, elbows and terminals.

Note: Use starter straight connector for vertical extension.

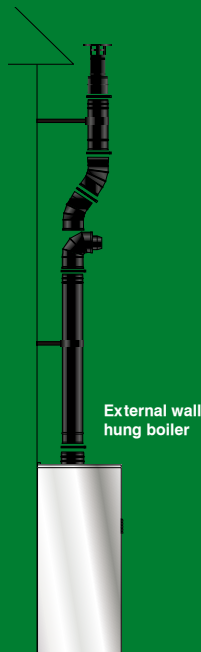

See page 11 for extensions, elbows and terminals.

Important

Components from the Orange and Green system can be used to construct Internal High Level, or Vertical Conventional flue systems using the flue adaptor kit CFA 15/70.

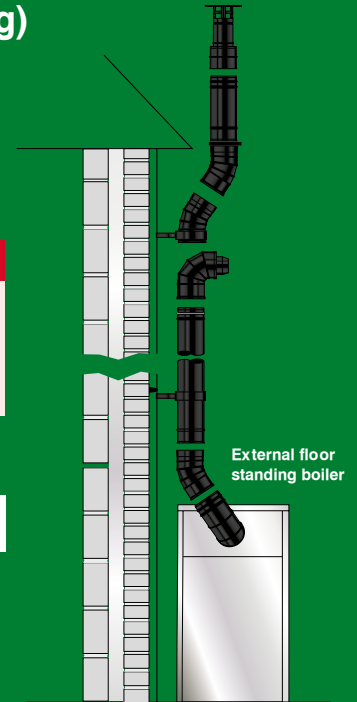

Maximum vertical length 19 metres

Accessories

External modules only

Important

* For Vortex Eco External 26-35kW models, use smaller size flue pipe.



External module starter straight

GKM90C Models up to 26kW*
GKM200C Models 26 - 70kW



External module starter elbow c/w test point

GKM90B Models up to 26kW*
GKM200B Models 26 - 70kW



Straight terminal only

GTL90B Models up to 26kW*
GTL200B Models 26 - 70kW

Horizontal solutions

See page 11 for extensions, elbows and terminals

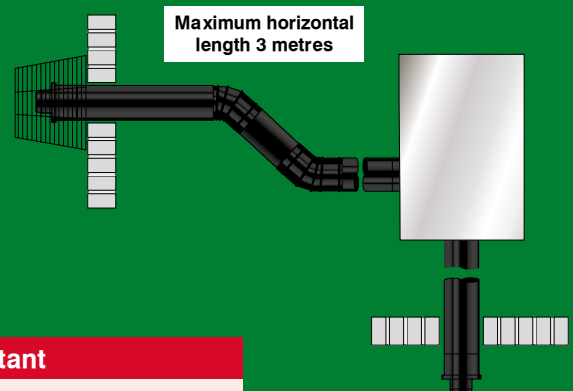

Maximum horizontal length 3 metres

Important

The maximum number of 45° elbows which can be used is two.

Flue adapter kit

For internal boilers only. See page 11 for extensions, elbows and terminals.

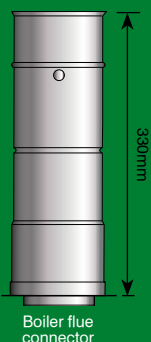

Boiler flue connector

Single to twin wall adaptor and boiler connector

CFA 15/70 Models 15 - 70kW

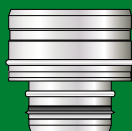

Single to twin wall adaptor



Locking band

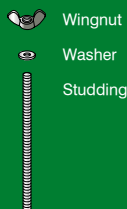

Wingnut
Washer
Studding

Note: Lubricating grease not shown.

Starter connectors

The starter elbow converts any of Grant's external modules or module combis to High Level or Vertical Conventional flue operation.

The starter straight connector allows the low-level discharge flue system of any Grant External module or module combi to be extended horizontally. The stainless steel flue components are fully insulated, have 'O' ring seals and locking bands, ensuring a rigid construction every time.

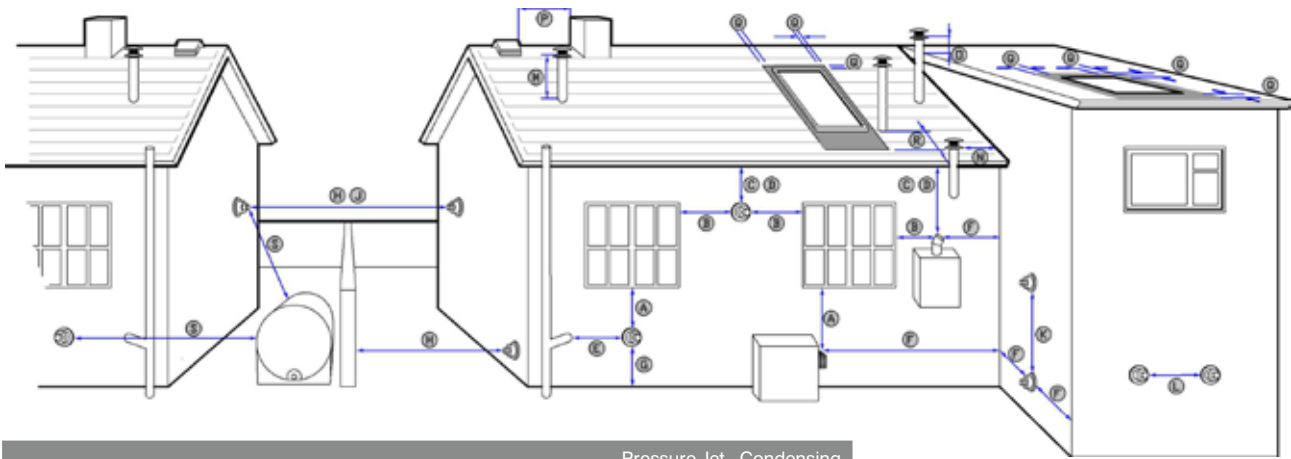

Ref	Location of outlet	Pressure Jet (mm)	Condensing (mm)
A	Directly below an opening, air brick opening, opening window, etc.	600	1000**
B	Horizontally to an opening, air brick opening, opening window, etc.	600	1000**
C	Below a gutter, eaves or balcony with protection	75*	1000**
D	Below a gutter, eaves or balcony without protection	600	1000**
E	From vertical sanitary pipework	300	
F	From an internal or external corner	300	
G	Above ground or balcony level	300	
H	From a surface or boundary facing the terminal	600	2500**
J	From a terminal facing the terminal	1200	
K	Vertically from a terminal on the same wall	1500	
L	Horizontally from a terminal on the same wall	750	
M	Above the highest point of an intersection with the roof	600	
N	From a vertical structure to the side of the terminal	750	
O	Above a vertical structure less than 750 mm from the side of the terminal	600	
P	From a ridge terminal to a vertical structure on the roof	1500	
Q	Above or to the side of any opening on a flat or sloping roof	300	
R	Below any opening on a sloping roof	1000	
S	From oil storage tank (Class 1)	1800***	

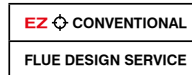

Individually designed conventional flue systems for modular boiler installations.

Grant UK offers a unique customised design service, where two or more boilers are connected in a modular form to a single conventional flue stack. This service includes the design and supply of flue headers and flue systems for condensing boiler installations and is available to merchants upon completion of a simple site survey form. Contact our technical department on: **+44 (0)1380 736920** for further details.

Note:

- * A heat shield at least 750mm wide must be fitted to provide protection of combustible material
 - ** Clearances required by BS 5410-1:2014 to alleviate the effect of plume nuisance. If a risk assessment shows that there will be no impact from pluming, then the 'pressure jet' figure could apply - seek confirmation from Local Authority Building Control.
 - *** Seek guidance from OFTEC Book 3 (Oil Storage and Supply).
 - 1. Appliances burning class D fuel have additional restrictions. Refer to BS 5410-1:2014.
 - 2. Vertical structure in N, O and P includes tank or lift rooms, parapets, dormers, etc.
 - 3. Terminating positions A to L are only permitted for appliances that have been approved for low level flue discharge when tested in accordance with BS EN 303-1, OFS A100 or OFS A101.
 - 4. Terminating positions should be at least 1.8 metres from an oil storage tank (Class 1) unless a wall with at least 30 minutes fire resistance and extending 300 mm higher and wider than the tank is provided between the tank and the terminating position.
 - 5. Where a flue is terminated less than 600 mm away from a projection above it and the projection consists of plastics or has a combustible or painted surface, then a heat shield of at least 750 mm wide should be fitted to protect these surfaces.
 - 6. If the lowest part of the terminal is less than 2 metres above the ground, balcony, flat roof or other place to which any person has access, the terminal should be protected by a guard.
 - 7. Notwithstanding the dimensions given above, a terminal should not be sited closer than 300 mm to combustible material. In the case of a thatched roof, double this separation distance should be provided. It is also advisable to treat the thatch with a fire retardant material and close wire in the immediate vicinity of the flue.
 - 8. A flue or chimney should not pass through the roof within the shaded area delineated by dimensions Q and R.
 - 9. Where protection is provided for plastics components, such as guttering, this should be to the standard specified by the manufacturer of the plastics components.
 - 10. Terminals must not be sited under car ports.
 - 11. Terminals at low levels (terminals under 2.1 metres) have more restrictive recommendations and should not be positioned near public footways, frequently used access routes, car parking spaces less than 2.5 metres from the terminal or patio's (hard surface area).
- Further guidance can be obtained from BS 5410-1:2014, OFTEC Book 4 (Installation) and Approved Document J.
Grant UK flue products are fully compliant with the CE (Communauté Européenne/European Community) standards having undergone rigorous product testing.



Grant Engineering (UK) Ltd
Hopton House, Hopton Industrial Estate,
Devizes, Wiltshire, SN10 2EU

t: +44 (0)1380 736920 f: +44 (0)1380 736991
e: sales@grantuk.com w: www.grantuk.com



This leaflet is accurate at the time of printing but as Grant UK has a policy of continual improvement it may be superseded. We reserve the right to amend specifications without prior notice. The statutory rights of the consumer are not affected.

All products manufactured under I.S. EN ISO 9001. Grant UK additionally holds ISO 14001 accreditation.

™ THE GRANT 'EZ-FIT FLUE' SYSTEM is a trade mark of Grant Engineering Limited.

©Grant Vortex, Grant VortexBlue, Grant Vortex Air, Grant Aerona, Grant Spira, Grant SpiraPod, Grant SpiraVac, Grant Vecta, Grant Solar, Grant Aurora, Grant Sahara, Grant CombiSOL, Grant WinterSOL, Grant MonoWave, Grant DuoWave, Grant ThermoWave, Euroflame and Multi Pass are registered trade marks of Grant Engineering Limited. The contents of this leaflet are fully protected by copyright and nothing may be reproduced without permission from Grant UK.



UKBEZFG RE0818