

COMPACT 400
WALL HUNG
FAN FLUE ROOM SEALED
GAS COMBIANATION BOILER

Installation and servicing instructions

MODEL

20/1 MFS

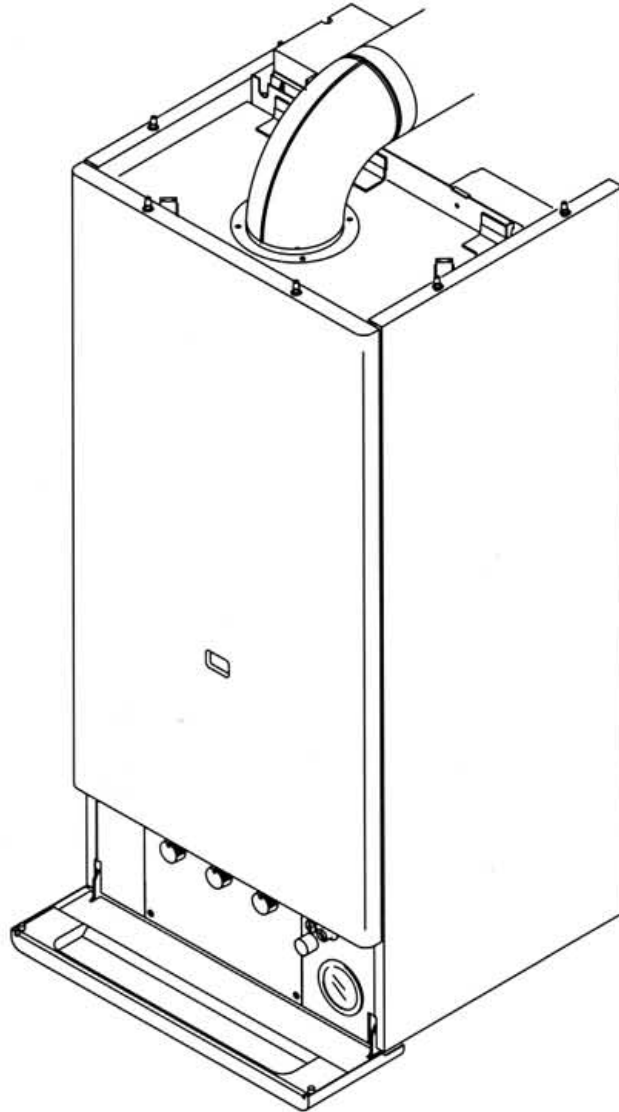

British Gas Tested and Certified
G. C. No. 47 116 01

This boiler is for use with natural gas only

**LEAVE THESE INSTRUCTIONS
ADJACENT TO THE GAS METER**

MTS (GB) LIMITED
MTS Building Hughenden Avenue, High Wycombe
Bucks HP13 5FT
Telephone (0494) 459 711 – Fax (0494) 459 775

 **ARISTON**

TABLE OF CONTENTS

| sect. | subject | page No. | | | |
|----------|--|-----------|----------|---|-----------|
| 1 | General information | 1 | 6.13 | Insulation panels | 28 |
| 1.1 | Overall view | 1 | 6.14 | Gas modulator cartridge | 28 |
| 1.2 | Technical data | 2 | 6.15 | On-off operator coils | 29 |
| 1.3 | Description | 3 | 6.16 | Gas modulator coil | 29 |
| 1.4 | Flue pipes optional extras | 3 | 6.17 | Gas valve | 30 |
| 1.5 | Design principles and operating sequence | 4 | 6.18 | Fan and venturi device | 30 |
| 2 | General requirements | 6 | 6.19 | Air pressure switch | 31 |
| 2.1 | Related documents | 6 | 6.20 | Main heat exchanger | 31 |
| 2.2 | Location of appliance | 6 | 6.21 | Main circuit temperature probe | 31 |
| 2.3 | Flue system | 6 | 6.22 | Pump | 31 |
| 2.4 | Gas supply | 6 | 6.23 | Main circuit flow switch | 32 |
| 2.5 | Air supply | 7 | 6.24 | Pump pressure switch | 32 |
| 2.6 | Water circulation (central heating) | 7 | 6.25 | Temperature-pressure gauge | 33 |
| 2.7 | Domestic water | 8 | 6.26 | By-pass | 33 |
| 2.8 | Electrical supply | 8 | 6.27 | Automatic air release valve | 33 |
| 3 | Installation | 9 | 6.28 | Expansion vessel | 33 |
| 3.1 | Delivery | 9 | 6.29 | Safety valve | 34 |
| 3.2 | Measurements for installing the appliance | 9 | 6.30 | 3-way valve | 34 |
| 3.3 | Assembling the wall mounting bracket | 10 | 6.31 | D.h.w. heat exchanger | 35 |
| 3.4 | Drilling the hole for the flue | 10 | 6.32 | D.h.w. temperature probe | 37 |
| 3.5 | Unpacking the boiler | 11 | 6.33 | D.h.w. flow switch | 37 |
| 3.6 | Mounting the boiler on the bracket | 12 | 6.34 | Water unit | 38 |
| 3.7 | Mounting the flue exhaust pipes | 13 | 6.35 | O-rings position on the d.h.w. heat exch. | 40 |
| 3.8 | Flue terminal guard | 15 | 7 | Fault finding | 41 |
| 3.9 | Electrical connections | 15 | 7.1 | Fault finding diagrams | 41 |
| 4 | Commissioning | 17 | 7.2 | Using the fault finding diagrams | 41 |
| 4.1 | Electrical installation | 17 | 7.3 | Special defects | 41 |
| 4.2 | Gas supply installation | 17 | 7.4 | Water leaks | 41 |
| 4.3 | Filling the d.h.w. system | 17 | 7.5 | Difficulty in lighting the burner | 41 |
| 4.4 | Initial filling of the system | 17 | 7.6 | Incorrect combustion | 41 |
| 4.5 | Setting the system pressure | 18 | 7.7 | Traces of gas or exhaust flues | 41 |
| 4.6 | Lighting the boiler | 18 | 7.8 | Appliance completely shut down | 42 |
| 4.7 | Checking the gas pressure at the burner | 19 | 7.9 | Fault of full sequence control p.c.b. | 44 |
| 4.8 | Checking the flue system | 20 | 7.10 | Fault on d.h.w. – c.h. switching | 46 |
| 4.9 | Checking the full sequence control | 20 | 7.11 | Fault on modulation | 48 |
| 4.10 | Testing the d.h.w. system flow | 20 | 8 | Electric diagrams | 50 |
| 4.11 | Selecting the pump operating modes | 20 | 8.1 | General wiring layout | 50 |
| 4.12 | Instructing the user | 21 | 8.2 | Functional flow diagrams | 51 |
| 5 | Maintenance | 22 | 9 | Short spare parts list | 56 |
| 5.1 | General | 22 | | | |
| 5.2 | Recommended routine maintenance | 22 | | | |
| 6 | Servicing instructions | 23 | | | |
| 6.1 | Replacement of parts | 23 | | | |
| 6.2 | To gain general access | 23 | | | |
| 6.3 | To drain the main circuit of the boiler | 24 | | | |
| 6.4 | To drain the d.h.w. circuit of the boiler | 25 | | | |
| 6.5 | Setting gas pressures | 25 | | | |
| 6.6 | Reducing the maximum output to meet the central heating power requirements | 25 | | | |
| 6.7 | Electronic regulation p.c.b. | 26 | | | |
| 6.8 | Full sequence control p.c.b. | 26 | | | |
| 6.9 | Overheat thermostat | 27 | | | |
| 6.10 | Burner | 27 | | | |
| 6.11 | Injectors | 28 | | | |
| 6.12 | Ignition and/or detection electrodes | 28 | | | |

1 GENERAL INFORMATION

1.1 Overall view

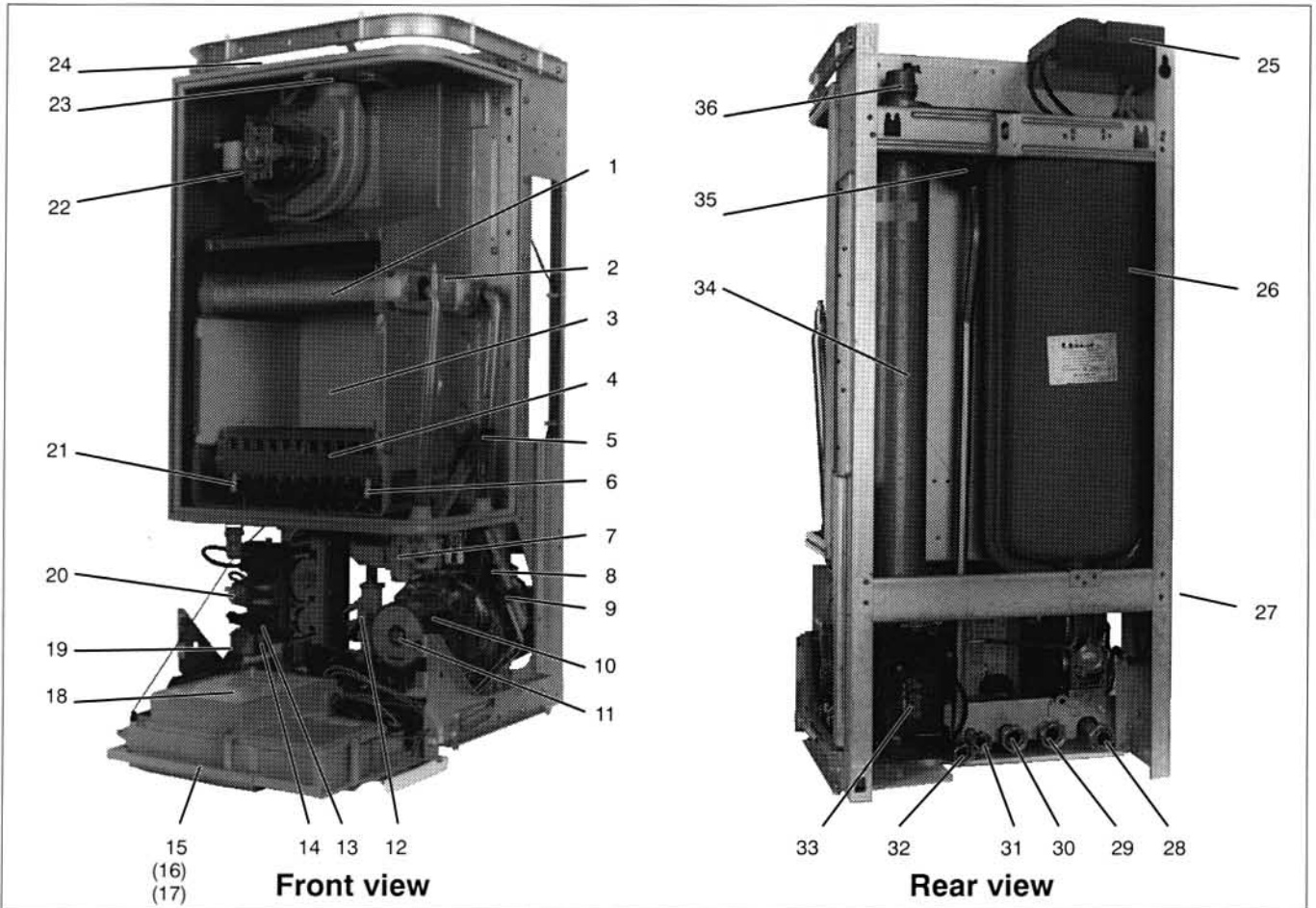

- | | |
|---|--|
| 1 Main heat exchanger | 24 Flue gas sampling point |
| 2 Manual vent cock | 25 Air pressure switch |
| 3 Combustion chamber | 26 Expansion vessel |
| 4 Burner | 27 Data badge |
| 5 Overheat thermostat (probe) | 28 Gas inlet |
| 6 Detection electrode | 29 Central heating (c.h.) water return |
| 7 Main circuit flow switch | 30 C.h. water flow |
| 8 Main circuit temperature probe | 31 Domestic hot water (d.h.w.) inlet |
| 9 Thermometer probe | 32 D.h.w. outlet |
| 10 Pump | 33 3-way valve |
| 11 Pump plug | 34 D.h.w. heat exchanger |
| 12 D.h.w. flow switch | 35 D.h.w. temperature probe |
| 13 Pressure test point for measuring outlet pressure at the gas valve | 36 Automatic air release valve |
| 14 Pressure test point for measuring inlet pressure at the gas valve | 37 Safety valve |
| 15 Control panel | 38 Divertor on 3-way valve |
| 16 Electronic regulation p.c.b.* | 39 Injector |
| 17 Full sequence control p.c.b.* | 40 Pump pressure switch |
| 18 Wiring diagram | 41 D.h.w. filter |
| 19 Gas valve | 42 D.h.w. flow limiter |
| 20 Gas modulator | 43 By-pass |
| 21 Ignition electrode | 44 Main circuit drainage cock |
| 22 Fan | 45 D.h.w. circuit drainage cock |
| 23 Venturi device | 46 Air intake |
| | 47 Flue outlet |

* component enclosed in the control panel.

General information

1.2 Technical data

| | | |
|-------------|----------|--------------|
| Heat input: | | |
| max | 28,74 kW | 98 080 Btu/h |
| min | 12,40 kW | 42 317 Btu/h |

| | | |
|--------------|----------|--------------|
| Heat output: | | |
| max | 23,25 kW | 79 344 Btu/h |
| min | 8,71 kW | 29 274 Btu/h |

Central heating

| | | |
|------------------------|-------|--|
| Operating temperature: | | |
| max | 85 °C | |
| min | 35 °C | |

| | | |
|------------------|-------|-------------|
| Working pressure | | |
| max | 3 bar | 43,5 p.s.i. |

| | | |
|---------------|-----------|------------|
| Water content | 6,25 lts. | 1,37 gals. |
|---------------|-----------|------------|

Built in expansion vessel:

| | | |
|---------------------|----------|-------------|
| Total capacity | 7,5 lts. | 1,65 gals. |
| Pre-charge pressure | 0,7 bar | 10,1 p.s.i. |

| | | |
|--|------------|--------------|
| Available head at 1000 litres/hr (220 gals/hr) | | |
| | 3,2 m w.g. | 126 ins w.g. |

| | | |
|--------------------------------------|-------|--|
| Temp. difference for flow and return | 20 °C | |
|--------------------------------------|-------|--|

| | | |
|--|--------------|-------------|
| Flow rate of water through the appliance | 1 000 lts./h | 220 gals./h |
|--|--------------|-------------|

Max permissible cold water capacity without additional expansion vessel*

| | | |
|--|---------|------------|
| | 71 lts. | 15,6 gals. |
|--|---------|------------|

Domestic hot water

| | | |
|------------------------|-------|--|
| Operating temperature: | | |
| max | 65 °C | |
| min | 37 °C | |

| | | |
|-------------------|---------|------------|
| Working pressure: | | |
| max | 10 bar | 145 p.s.i. |
| min | 0,2 bar | 2,9 p.s.i. |

| | | |
|---------------|-----------|------------|
| Water content | 0,38/lts. | 0,08 gals. |
|---------------|-----------|------------|

flow rate:

| | | |
|------------|---------------|---------------|
| min | 2,0 lts./min | 0,4 gals./min |
| 30 °C rise | 11,1 lts./min | 2,4 gals./min |
| 35 °C rise | 9,5 lts./min | 2,0 gals./min |
| 40 °C rise | 8,3 lts./min | 1,8 gals./min |

Gas requirements

| | | |
|--------------|------------------------|-------------------------|
| max gas rate | 2,79 m ³ /h | 98,5 ft ³ /h |
| min gas rate | 1,04 m ³ /h | 36,7 ft ³ /h |

| | | |
|----------------|---------|-------------|
| Inlet pressure | 20 mbar | 7,9 in w.g. |
|----------------|---------|-------------|

| | | |
|------------------|----------|-------------|
| Burner pressure: | | |
| max | 9,7 mbar | 3,9 in w.g. |
| min | 1,4 mbar | 0,6 in w.g. |

| | | |
|------------------|-----------|--|
| Burner injectors | 12 x 1.35 | |
|------------------|-----------|--|

Component details

| | | |
|-------------------|----------|----------|
| Gas control valve | SIT | 827 nova |
| Burner | Polidoro | |

Electrical data

| | | |
|-------------------------|------------|--|
| Electrical supply | 240 V~ | |
| Frequency | 50 Hz | |
| Power consumption | 150 W | |
| External fuse rating | 3 A | |
| Internal fuse rating F1 | 0,08 A T** | |
| Internal fuse rating F2 | 1,6 A T** | |

Connections

| | |
|-----------------------|------------|
| Gas connection | 15 mm o.d. |
| c.h. flow | 22 mm o.d. |
| c.h. return | 22 mm o.d. |
| D.h.w. inlet | 15 mm o.d. |
| D.h.w. outlet | 15 mm o.d. |
| Safety discharge pipe | 15 mm o.d. |

Flue pipes specifications

| | | |
|--------------------|----------|------------|
| Outer diameters: | | |
| flue exhaust pipe | 60 mm | 2,36 ins |
| Air intake pipe | 100 mm | 3,93 ins |
| Standard length | 850 mm | 33,46 ins |
| Maximum length *** | 3 000 mm | 118,11 ins |

Other specifications

| | | |
|------------|--------|----------|
| Height | 967 mm | 38,1 ins |
| Width | 400 mm | 15,7 ins |
| Depth | 370 mm | 14,5 ins |
| Dry weight | 50 kg | 110 lb |

* If required an external expansion vessel can be fitted

** Spare fuses are available in housing of the electronic regulation p.c.b.

*** Using one or more *horizontally elongated flue pipes* kit (see sect. 1.4).

General information

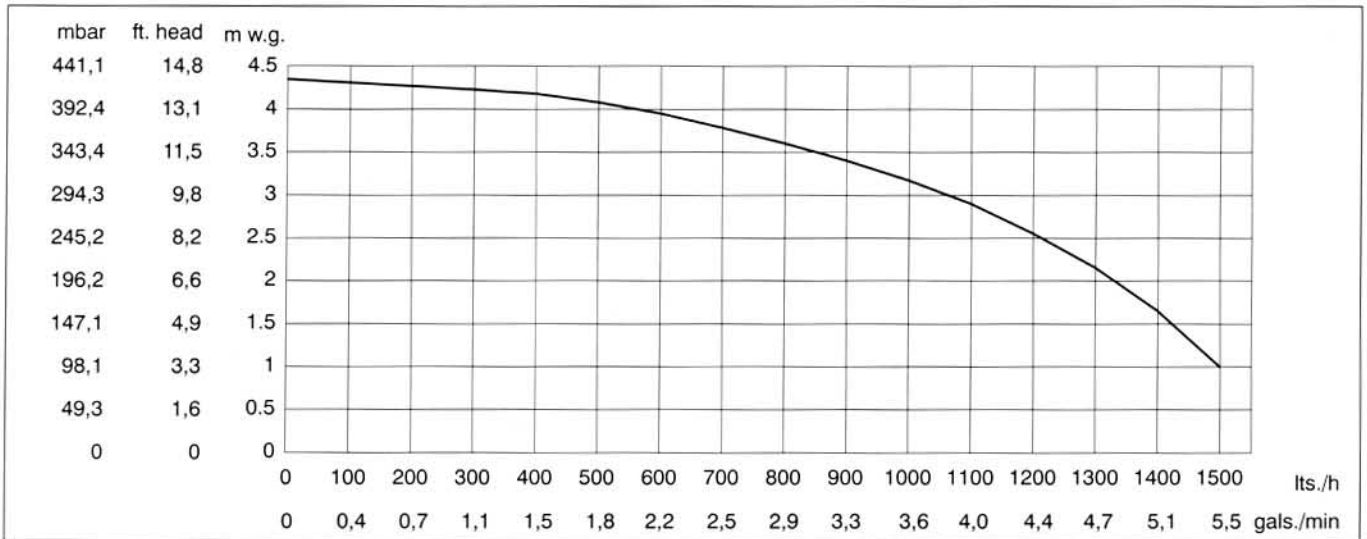

fig. 1.1

Available pump head

The curve in fig. 1.1 shows the water pressure (head) available to the central heating (c.h.) circuit as a function of flow; the load loss of the appliance has already been subtracted.

1.3 Description

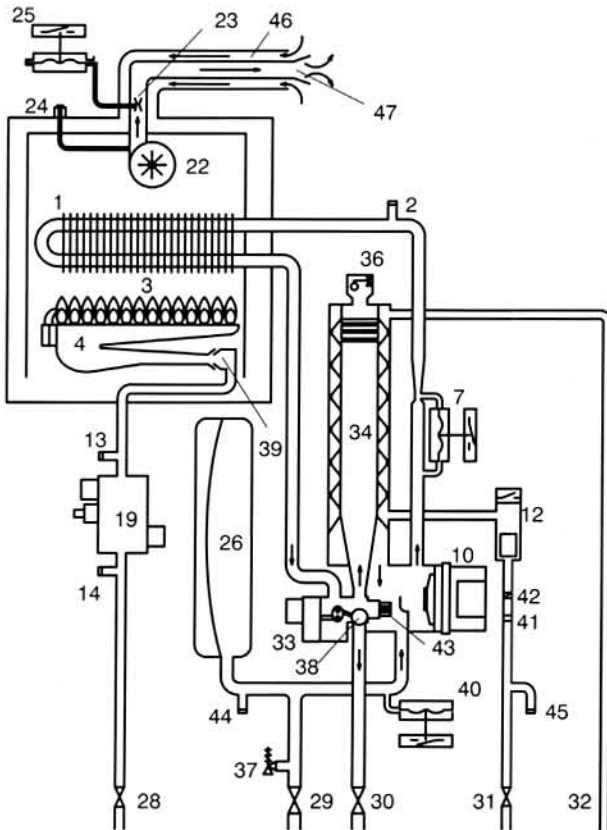

fig. 1.2

The ARISTON 20/1 MFS is a combined central heating (c.h.) and domestic hot water (d.h.w.) appliance.

ARISTON 20/1 MFS

It is produced as a room sealed category appliance suitable for wall mounting applications only.

This boiler is suitable only for sealed systems.

It incorporates:

- full sequence electronic ignition system
- fan powered flue outlet with an annular co-axial combustion air intake which can be rotated through 360 degrees
- circulating pump
- expansion vessel
- temperature and pressure gauge
- safety valve
- 3-way valve

1.4 Flue pipes optional extras

The following items are available.

The respective mounting instructions are included in the carton containing the parts of the kit.

Horizontally elongated flue pipes

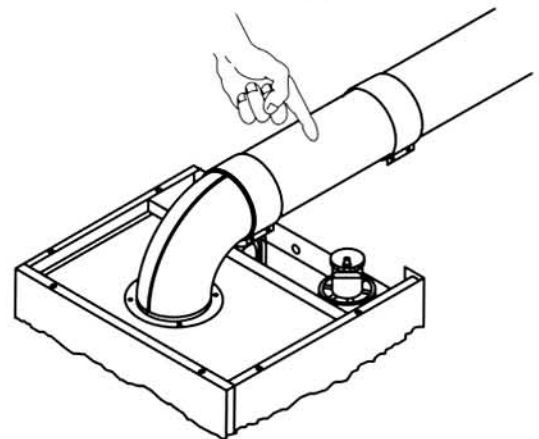

fig. 1.3

More than one section may be used but the total length of the exhaust duct must not exceed 3 m (9,84 ft).

Every section allows to extend the duct by 825 mm (32,48 ins).

Supplementary elbow

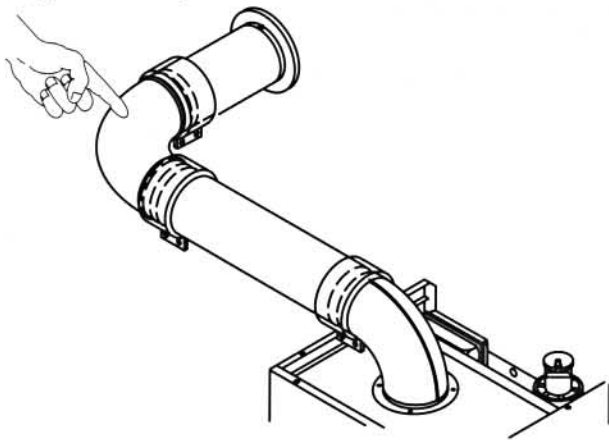

fig. 1.4

A single supplementary elbow only, can be used during installation: the length of the exhaust duct (standard elbow + the supplementary elbow included) must not exceed 1800 mm (5,9 ft).

Vertically elongated flue pipes

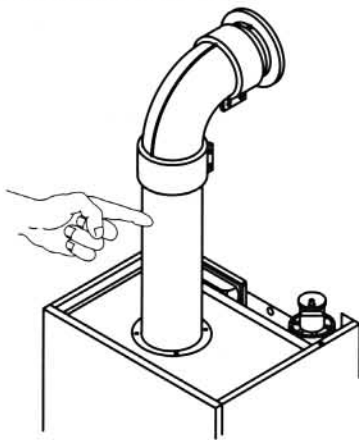

fig. 1.5

The kit marked *vertically elongated flue pipes* allows to rise the axis of the horizontal part of the exhaust duct.

1.5 Design principles and operating sequence

Water system design

The basic purpose of a boiler is to generate heat through the combustion of gas and to direct the heat through a water circuit, as required.

A combination-type appliance allows the heat to be used either for heating the environment and for heating hot water for domestic use.

Main water circuit

This is an internal water circuit in the appliance which passes through the main heat exchanger and absorbs heat directly from the combustion of gas. The water in this circuit is the same as the water that is circulated by the pump and flows through the c.h. system.

The path of the water in the main water circuit can be changed by a 3-way valve. The main water circuit is connected to the c.h. circuit during operation with the c.h. system (see fig. 1.6).

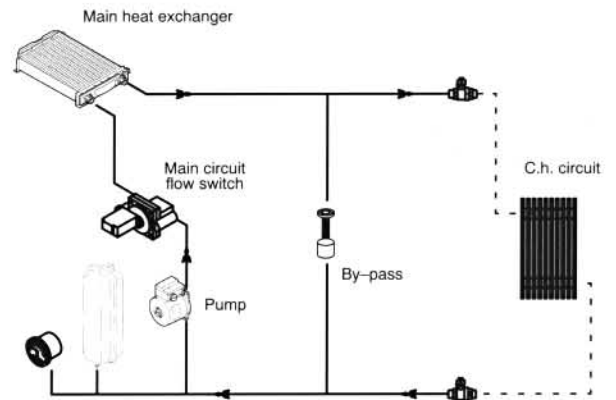

fig. 1.6

During operation as a d.h.w. heater, the main water circuit is directed through the d.h.w. heat exchanger (see fig. 1.7).

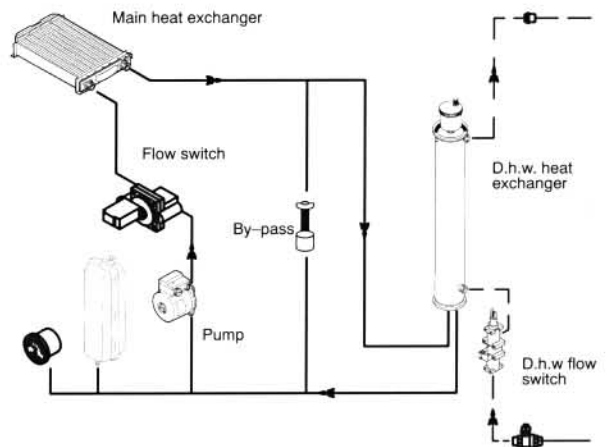

fig. 1.7

Also, a by-pass valve is installed in the main water circuit. The by-pass valve assures an adequate water flow through the main heat exchanger regardless of water flow conditions in the water circuit, thus avoiding damage due to temperature variations.

Safety devices

In both c.h. and d.h.w. modes safe operating is ensured by a pump pressure switch and a flow switch on main water circuit.

If the pressure in the main water circuit is insufficient the pump pressure switch disconnects the supply to the pump.

If the flow rate in the main water circuit is insufficient the flow switch on main water circuit disconnects the supply to the full sequence control p.c.b.

In both cases the boiler is stopped in order to prevent damages.

An overheat thermostat disconnects the two ON-OFF operators on the gas valve; as a result, the burner is shut down and the shut-down warning light will appear.

A safety valve is provided to relieve excess pressure from the main circuit.

General information

The appliance is equipped with a safety system (venturi device and air pressure switch) which senses the velocity of the exhaust flues. If the air pressure switch does not sense the correct velocity, the burner will shut down.

Operating sequence on central heating mode

The function switch must be set on  position.

The water in the main circuit is sent to the c.h. system when the 3-way valve is in the c.h. position. In this configuration, the diverter is in the upper position and the d.h.w. heat exchanger circuit is cut out.

The appliance is controlled by an electronic thermostat; water delivery temperature can be adjusted from 35°C to 85°C.

When heat is requested, a command reaches the full sequence control p.c.b.; this command starts the fan, which switches the air pressure switch. After the air pressure switch has been switched, the combustion chamber is purged of any residual unburned gasses for a few seconds. Next, the lighting cycle begins with a spark from the ignition electrode; at the same time, electrical power is fed to the two ON-OFF operators on the gas valve.

If the flame detection electrode does not sense the flame within 4 seconds from the beginning of the cycle, the full sequence control p.c.b. interrupts the lighting cycle, the electric spark is shut off and the power is disconnected from the two ON-OFF operators on the gas valve; as a result, the burner is shut down.

At this point, the shut down warning light appears and the reset push-button must be pressed to restart the lighting cycle.

If the detection electrode senses flames within 4 seconds from the beginning of the cycle, the full sequence control p.c.b. interrupts the electric sparks and holds the burner alight.

At the same time, the temperature of the heating circuit is measured by the main circuit temperature probe and this temperature is compared with the value set on the c.h. temperature adjustment ().

After lighting has been accomplished, the amount of flow from the gas valve is determined by the electronic regulation p.c.b.:

- when the temperature of the c.h. water is less than the preset temperature by a Δt value (difference between output and input temperature) between 6°C and 15°C, the appliance will supply heating power which ranges from 35 to 100% of its maximum capacity;
- when the temperature of the c.h. water is less than the preset temperature by a Δt value which is less than 6°C, the appliance will supply its minimum heating power (35% of its maximum heating power);
- if the minimum power is greater than the heat emitted from the radiators, the burner will shut down.



Heating power can be varied from 35 to 100% of the maximum rated power.

Operating sequence on d.h.w. mode

Whenever a d.h.w. tap is opened, the d.h.w. flow switch on the d.h.w. system is activated and a signal is sent to the electronic regulation p.c.b. This signal moves the shutter on the 3-way valve and thus closes the c.h. water circuit and opens the d.h.w. heat exchanger circuit.

The burner will operate at nominal power, or at a power rating which keeps d.h.w. at the constant temperature desired (as long as the demand for heating power does not exceed the nominal power supplied by the boiler). Thus, burner operation depends on the amount of d.h.w. used and the temperature which has been set on the d.h.w. temperature adjustment ().

D.h.w. only operation

When the function switch is set on  position, the c.h. adjustment system is deactivated, the 3-way valve is no longer actuated, the shutter closes water delivery to the c.h. circuit and opens delivery to the d.h.w. heat exchanger. When d.h.w. is withdrawn from the d.h.w. system, operation of the appliance will be the same as operation with the function switch set on  position.

2 GENERAL REQUIREMENTS

This appliance must be installed by a competent person in accordance with the Gas Safety (Installation & Use) Regulations 1984.

2.1 Related documents

The installation of this appliance must be in accordance with the relevant requirements of the Gas Safety (Installation & Use) Regulations (1984), the Local Building Regulations, the current I.E.E. Wiring Regulations, the by-laws of the local water undertaking, and in Scotland, in accordance with the Building Standards (Scotland) Regulation. Health and safety document n° 635 "Electricity at work regs. 1989".

It should be in accordance also with the following British Standard Codes of Practice:

| | | |
|---|-----------|------|
| Low pressure installation pipes | BS 6891 | 1988 |
| Boilers of rated input not exceeding 60 kW | BS 6798 | 1987 |
| Forced circulation hot water systems | BS 5449 | 1990 |
| Installation of gas hot water supplies for domestic purposes (2 nd family gases) | BS 5546 | 1990 |
| Flues | BS 5540-1 | 1990 |
| Air supply | BS 5540-2 | 1989 |

2.2 Location of appliance

The appliance may be installed in any room or internal space, although particular attention is drawn to the requirements of the current I.E.E. Wiring Regulations, and in Scotland, the electrical provisions of the Building Regulations applicable in Scotland, with respect to the installation of the combined appliance in a room containing a bath or shower.

Where a room-sealed appliance is installed in a room containing a bath or shower, any electrical switch or appliance control, utilising mains electricity should be so situated that it cannot be touched by a person using the bath or shower.

The location must permit an adequate space for servicing and air circulation around the appliance (see fig. 2.1).

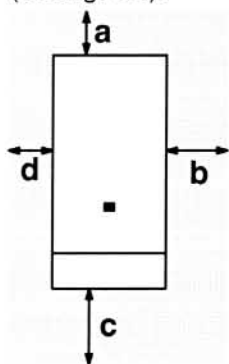

fig. 2.1

| | | |
|---|--------|----------|
| a | 155 mm | 6,1 ins |
| b | 130 mm | 5,1 ins |
| c | 500 mm | 19,7 ins |
| d | 50 mm | 1,9 ins |

The location must permit the provision of an adequate flue and termination.

For unusual locations special procedures may be necessary and BS 6798-1987 gives detailed guidance on this aspect.

A compartment used to enclose the appliance must be designed specifically for this purpose.

This appliance is not suitable for external installation.

2.3 Flue system

The provision for satisfactory flue termination must be made as described in BS 5440-1.

The appliance must be installed so that the flue terminal is exposed to external air.

It must not be installed so that the terminal discharges into an other room or space as an outhouse or lean-to. It is important that the position of the terminal allows a free passage of air across at all times.

The terminal should be located with due regard for the damage or discoloration that might occur to building products in the vicinity.

In cold and/or humid weather water vapour may condense on leaving the flue terminal; the effect of such "steaming" must be considered.

The minimum acceptable spacing from the terminal to obstructions and ventilation openings are specified in fig. 2.2.

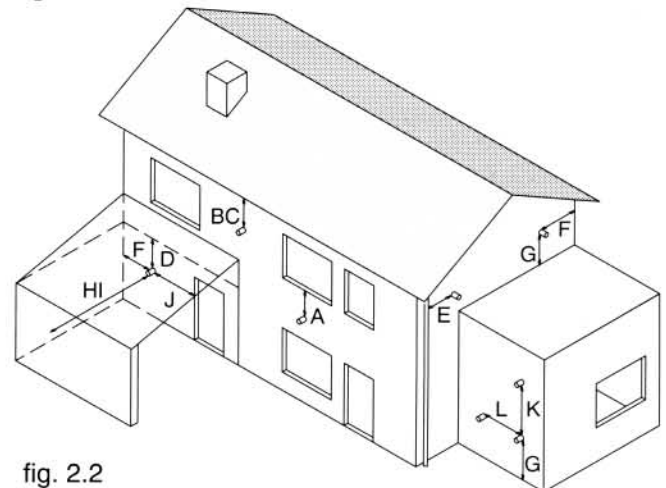

fig. 2.2

Terminal position

mm

| | | |
|------|---|-------|
| A .. | Directly below a open window or other opening | 300 |
| B .. | Below gutters, solid pipes or drain pipes | 75 |
| C .. | Below eaves | 200 |
| D .. | Below balconies or car port roof | 200 |
| E .. | From vertical drain pipes and soil pipes | 75 |
| F .. | From internal or external corners | 300 |
| G .. | Above ground or below balcony level | 300 |
| H .. | From a surface facing a terminal | 600 |
| I .. | From a terminal facing a terminal | 1 200 |
| J .. | From an opening in the car port (e.g. door, window) into dwelling | 1 200 |
| K .. | Vertically from a terminal in the same wall | 1 500 |
| L .. | Horizontally from a terminal in the same wall | 300 |

2.4 Gas supply

Gas meter is connected to the service pipe by the local gas region or a local gas region contractor.

If the gas supply for the boiler serves other appliances ensure that an adequate supply is available both to the

General requirements

boiler and the other appliance when they are in use at the same time.

Pipework must be of adequate size. Pipes of a smaller size than the boiler inlet connection should not be used.

Installation pipes should be fitted in accordance with BS 6891-1988 and the complete installation should be tested for soundness.

2.5 Air supply

The room in which the boiler is installed does not require a purpose provided air vent.

If installed in a cupboard or compartment, ventilation is also required for cooling.

Recommendations for air supply are detailed in BS 5440-2.

2.6 Water circulation (central heating)

Detailed recommendations are given in BS 6798-1987 and BS 5449-1 1990; the following notes are given for general guidance.

Pipework

Copper tubing to BS 2871-1 1977 is recommended for water pipes. Jointing should be either with capillary soldered or with compression fittings.

Where possible pipes should have a gradient to ensure air is carried naturally to air release points and water flows naturally to drain taps.

The appliance has a built-in automatic air release valve anyway, it should be ensured as far as possible that the appliance heat exchanger is not a natural collecting point for air.

Except where providing useful heat, pipes should be insulated to prevent heat loss and to avoid freezing.

Particular attention should be paid to pipes passing through ventilated spaces in roofs and under floors.

By-pass

The appliance includes an automatic by-pass valve which protects the main heat exchanger in case of reduced or interrupted water circulation through the heating system due to the closing of thermostatic valves or cock-type valves within the system.

The by-pass is calibrated to assure a minimum flow of 500-600 lts/hr through the main heat exchanger.

System design

This boiler is suitable only for sealed systems.

A typical lay-out is illustrated in the following figure.

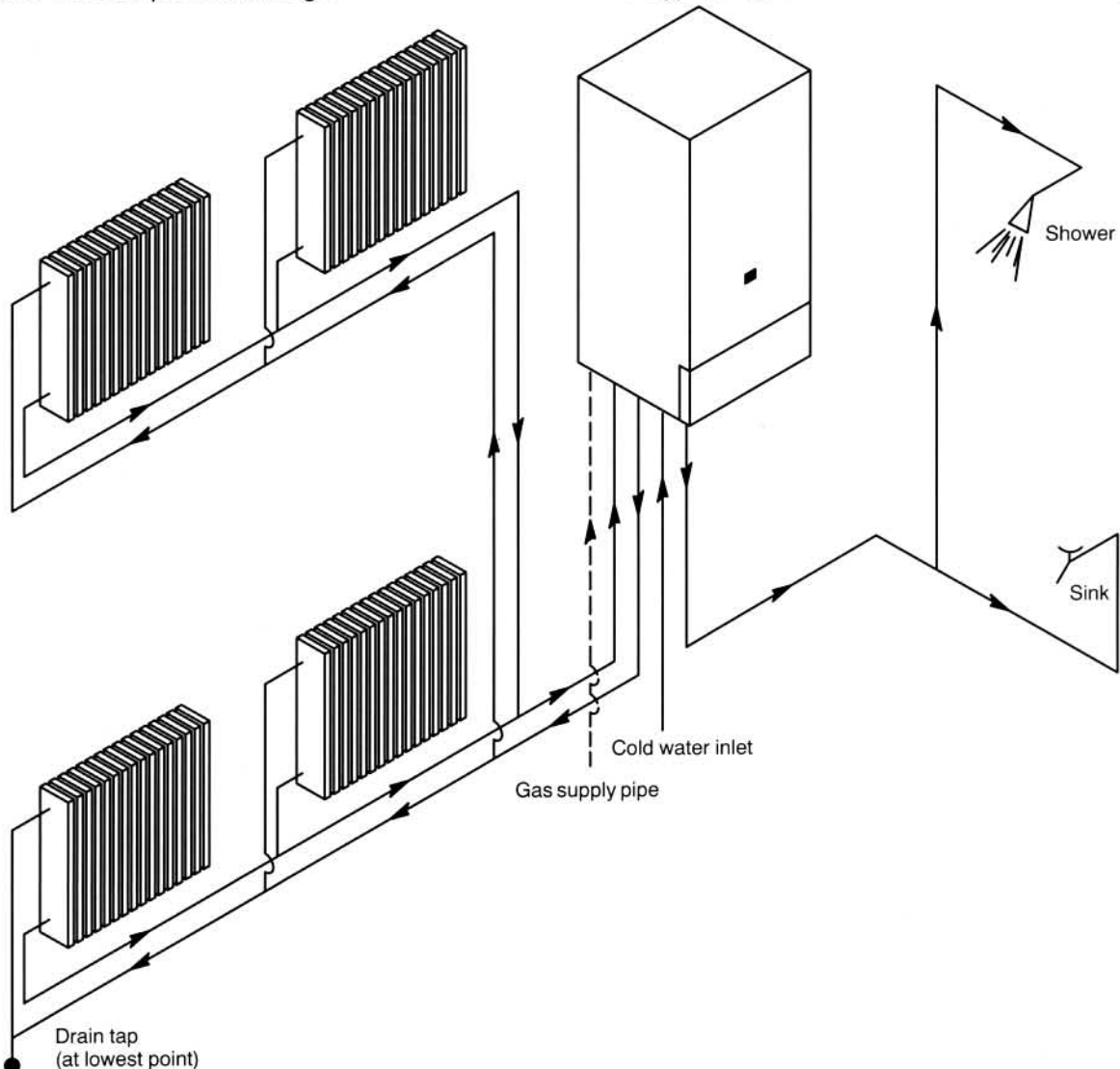

fig. 2.3

General requirements

These must be located in accessible positions to permit the draining of the whole systems. The taps must be at least 15 mm nominal size and manufactured in accordance with BS 2870 1980.

Air release points

These must be fitted at all high points where air will naturally collect and must be sited to facilitate complete fitting of the system.

The appliance has an integral sealed expansion vessel to accommodate the increase of water volume when the system is heated.

It can accept up to 7 lts (1,5 gals.) of expansion water.

If the heating circuit has an unusually high water content, calculate the total expansion and add additional sealed expansion vessel with adequate capacity.

Mains water feed: central heating

There must be no direct connection to the mains water supply even through a non return valve, without the approval of the Local Water Authority.

Filling

A method for initially filling the system and replacing water lost during servicing must be provided and it must comply with local water authority regulations.

A possible method is shown in fig. 2.4.

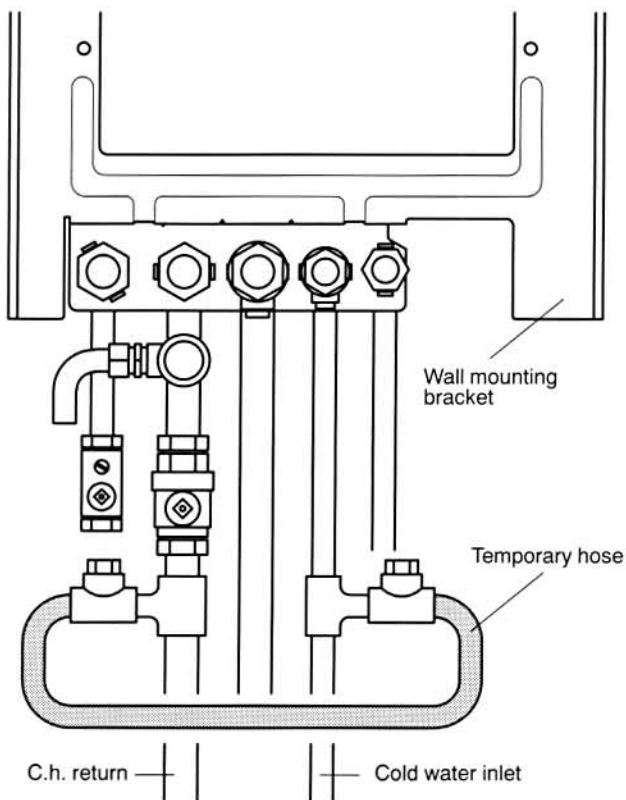

fig. 2.4

The installer should ensure that no leaks exist as frequent filling of the system could cause premature scaling of the heat exchanger.

2.7 Domestic water

The domestic water must be in accordance with the relevant recommendations of BS 5546. Copper tubing to BS 2871-1 is recommended for water carrying pipework and must be used for pipework carrying potable water.

2.8 Electrical supply

Warning, this appliance must be earthed.

External wiring to the appliance must be carried out by a competent person and be in accordance with the current I.E.E. Regulations and local regulations which apply.

The ARISTON 20/1 MFS is supplied for connection to a 240 V~ 50 Hz supply. The supply must be fused at 3A.

The method of connection to the electricity supply must facilitate complete electrical isolation of the appliance by the use of a fused double pole isolator having a contact separation of at least 3 mm in all poles or alternatively, by the use of a 3A fused three pin plug and unswitched shuttered socket outlet both complying with BS 1363.

The point of connection to the electricity supply must be readily accessible and adjacent to the appliance except where the appliance is installed in a bathroom this must be sited outside the bathroom.

3 INSTALLATION

3.1 Delivery

There will be 3 items:

- 1 the boiler fully assembled;
- 2 the wall mounting bracket with cocks and pipes;
- 3 Standard flue assembly which include flue pipes and 90° elbow.

3.2 Measurements for installing the appliance

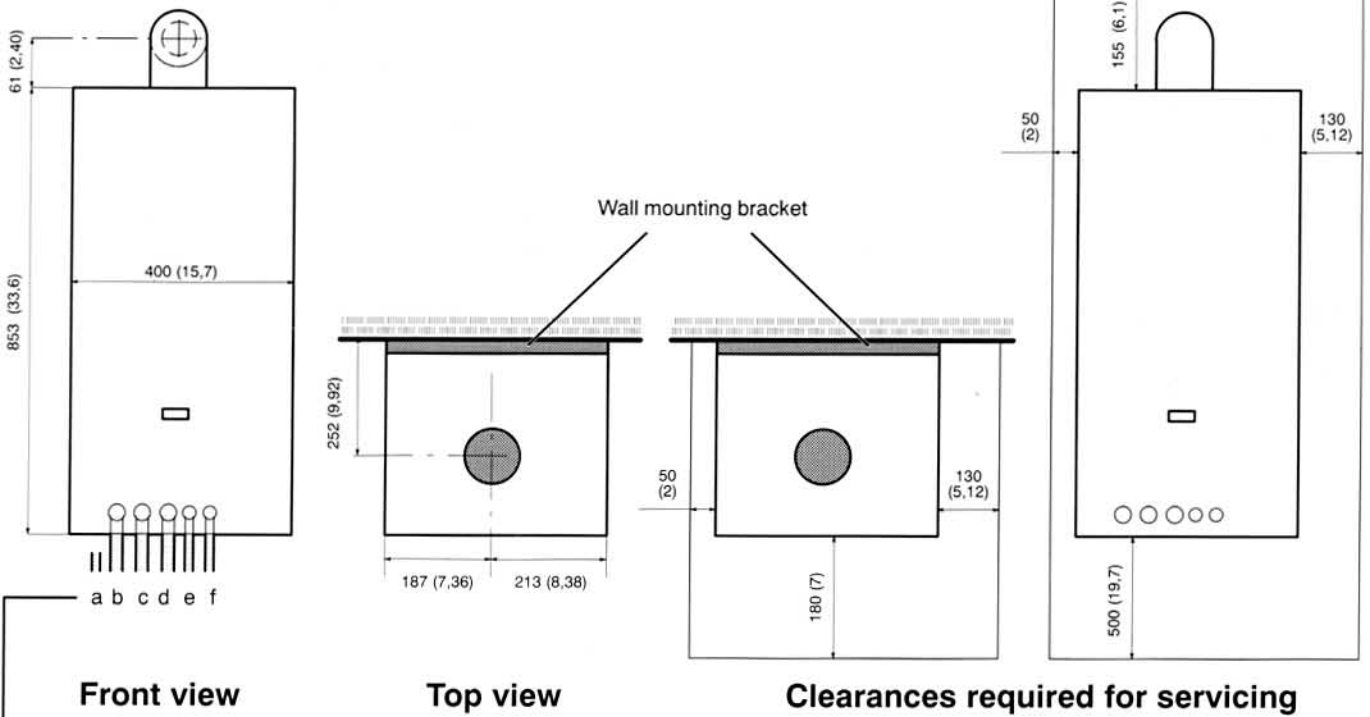

Front view

Top view

Clearances required for servicing

- a – safety valve discharge pipe
- b – gas
- c – c.h. water return
- d – c.h. water flow
- e – d.h.w. inlet
- f – d.h.w. outlet

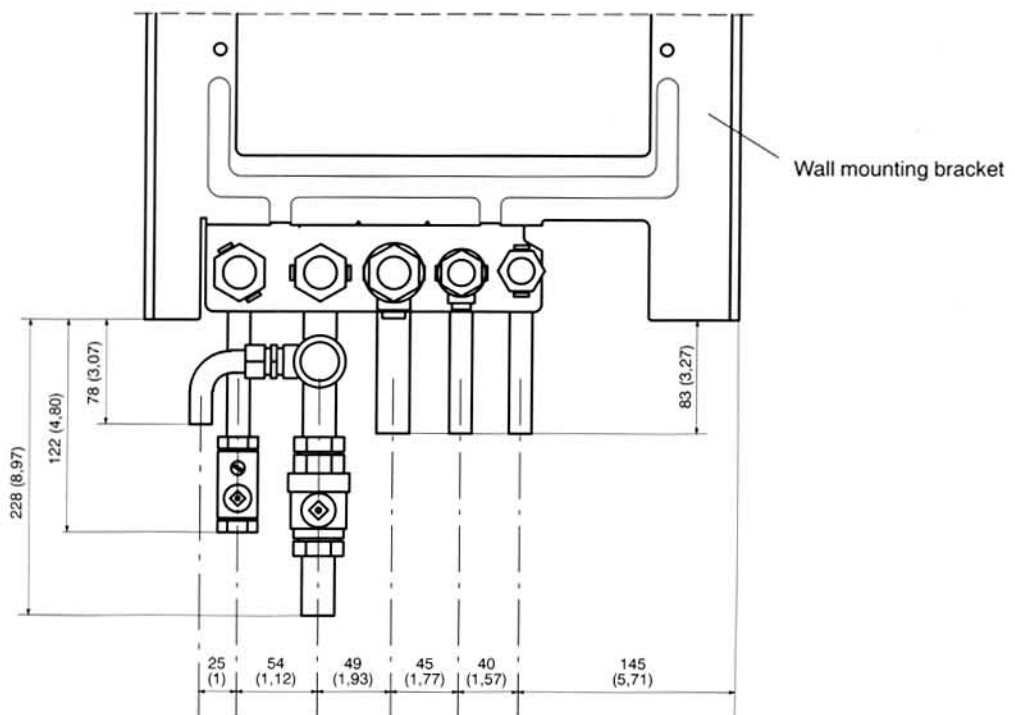

All measurements are in millimetres (inches in brackets)

3.3 Assembling the wall mounting bracket

The carton marked *wall mounting bracket* contains the following:

- 1 mounting bracket;
- 2 1/2" cock for d.h.w. inlet;
- 3 3/4" cocks for c.h. flow and return;
- 4 1/2" nipples for d.h.w. and safety valve outlet;
- 5 3/4" gaskets;
- 6 3/4" nuts for mounting 3/4"cocks and gas pipe;
- 7 3/4" nipple for c.h. return;
- 8 ø 15 mm o.d.pipe for safety valve discharge;
- 9 ø 22 mm o.d. pipe for c.h. return with 3/4" connector nut;
- 10 ø 22 mm o.d. pipe for c.h. flow with 3/4" connector nut;
- 11 ø 15 mm o.d.pipes for d.h.w circuit;
- 12 ø 15 mm o.d.pipe for gas inlet;
- 13 c.h. return pipe with safety valve connection;
- 14 safety valve;
- 15 1/2" nuts for mounting the 1/2" cock and nipple;
- 16 1/2" gaskets;
- 17 1/2" connector nuts;
- 18 15 mm compression fitting cock for gas inlet.

- Position the mounting bracket on the wall. Use a spirit level to make sure that the support is level;
- mark the attachment points through the holes indicated;
- remove the wall mounting bracket and drill holes in the wall at the points marked;
- use screws with wall plugs ø 8 mm to attach the wall mounting bracket to wall;

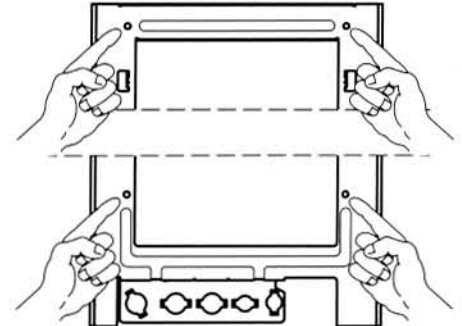
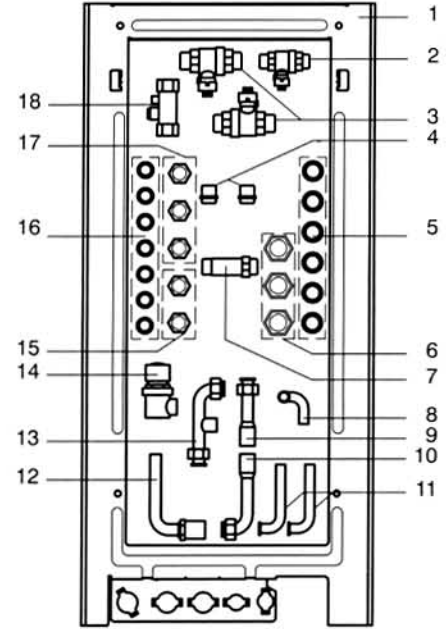

3.4 Drilling the hole for the flue

- Drill a hole with a diameter of at least 110 mm (4,33 ins) in the wall; for correct position see sect. 3.2.
Drill the hole in the direction of the flue exhaust pipe so that the duct will have a slight downward inclination to the outside;

- mount the cocks and fittings on the bottom of the wall mounting bracket and tighten with the nuts;
- use the connector nuts to connect the pipes to their respective cocks.
Be sure to use the correct gaskets when installing the pipes;
- connect valves and pipes from right to left;

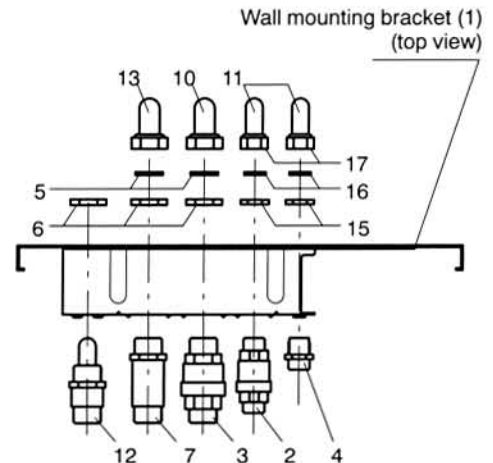

Installation

- mount the cock for gas inlet (18) and the 3/4" cock for c.h. return (3). Be sure to use the correct gaskets.
- mount the pipe for c.h. return (9);

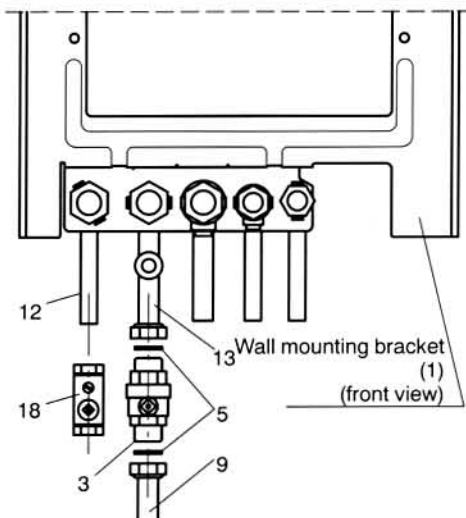

- mount the safety valve (14) on the c.h. return pipe (13) with a 1/2" gasket. The valve must be mounted with its outlet towards the left hand.
- Mount the 1/2" nipple (4) and the pipe for the safety valve discharge (8) with the correct gaskets as indicated. Connect discharge pipe to enable it to discharge externally at low level;
- connect cocks to corresponding pipes within the appliance using the correct washers supplied;
- complete the installation connecting the pipes to the other parts of the plant. Make water heating and gas connections to the appliance.

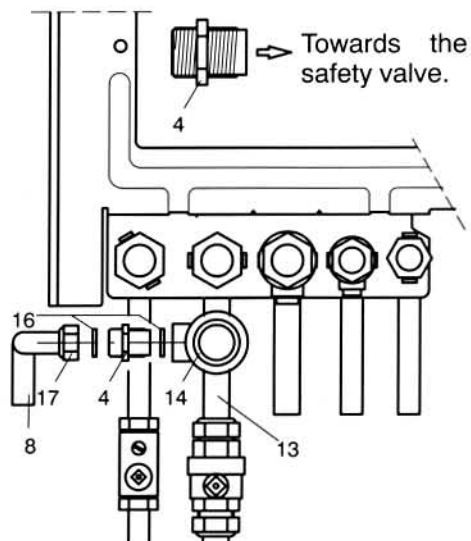

3.5 Unpacking the boiler

- Open the side of the carton marked *opening side*;

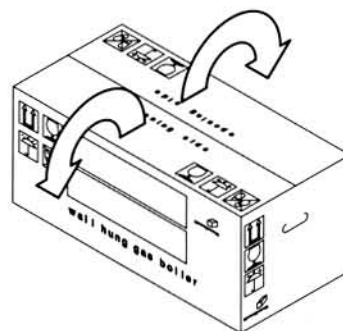

- overturn the carton keeping the flaps open;

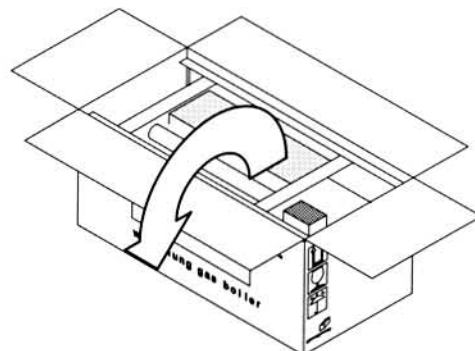

installation

- lift up the carton;

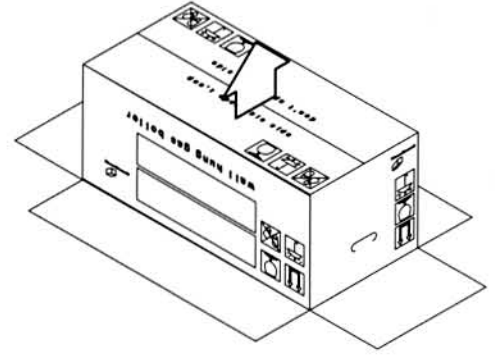

- rest the boiler on the floor and remove the polystyrene guards.

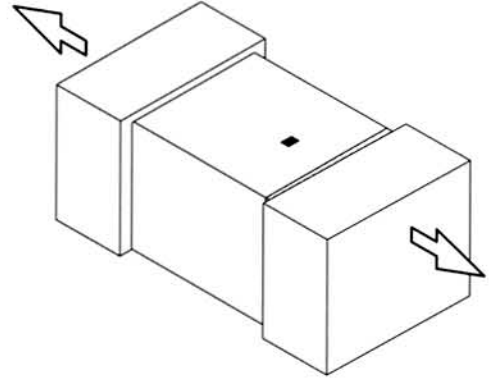

3.6 Mounting the boiler on the bracket

- Remove the protection caps from the pipes on the boiler;
- carefully clean the cocks and connections mounted on the wall mounting bracket;
- hang the appliance on the bracket;
- remove the lower protection plate (sect. 6.2);
- install connectors on the pipes (use the original gaskets supplied with the wall mounting bracket);
- tighten the connectors securely;
- re-install the lower protection plate.

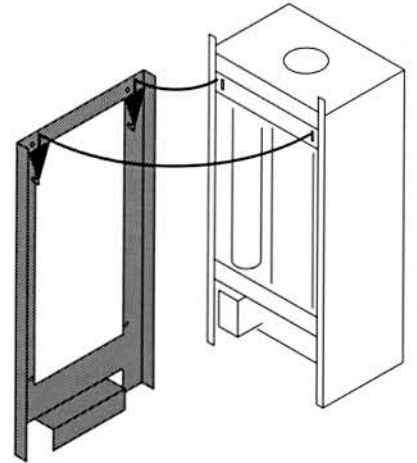

3.7 Mounting the flue exhaust pipes

Open the carton marked *standard flue exhaust pipes*.
It contains the following:

- 19 flue exhaust pipe with wind-resistant terminal;
- 20 pipe support
- 21 self-tapping screws 3,5 x 19 mm;
- 22 springs for the tightening band;
- 23 gasket tightening band;
- 24 gasket which seals the elbow to the flue duct;
- 25 gasket which seals the elbow to the surface of the appliance;
- 26 self-tapping screws 4,8 x 9,5 mm;
- 27 90° elbow;
- 28 suction pipe – ø100 mm;
- 29 wall gaskets;
- 30 self-tapping screws 4,8 x 13 mm.

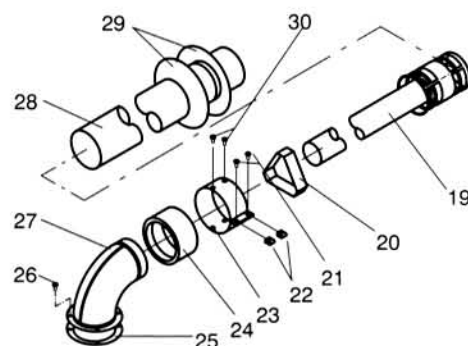

Cutting the flue exhaust pipes

If your particular installation requires you to shorten the duct, see the following instructions for cutting measures.

If you need to extend the flue duct or change its direction, optional kits are available (sect. 1.4).

All measures are in millimetres (inches in brackets).

Both pipes must be cut on the side facing the elbow.

Rear outlet

$$L_s = L_x + 173 \text{ (6,81)}$$

$$L_e = L_x + 322 \text{ (12,68)}$$

$$L_s \text{ max} = 775 \text{ (30,51)}$$

$$L_e \text{ max} = 928 \text{ (36,53)}$$

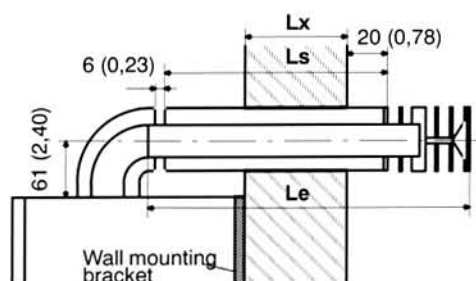

Right side outlet

$$L_1 \text{ min} = 130 \text{ (5,11)}$$

$$L_s = L_x + L_1 + 134 \text{ (5,27)}$$

$$L_e = L_x + L_1 + 287 \text{ (11,30)}$$

$$L_s \text{ max} = 775 \text{ (30,51)}$$

$$L_e \text{ max} = 928 \text{ (36,53)}$$

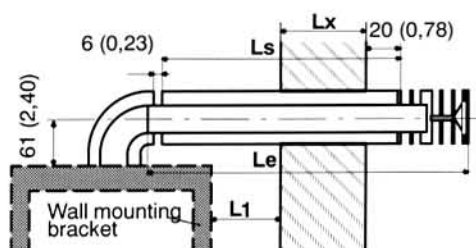

Left side outlet

$$L_2 \text{ min} = 50 \text{ (1,97)}$$

$$L_s = L_x + L_2 + 108 \text{ (4,25)}$$

$$L_e = L_x + L_2 + 261 \text{ (10,27)}$$

$$L_s \text{ max} = 775 \text{ (30,51)}$$

$$L_e \text{ max} = 928 \text{ (36,53)}$$

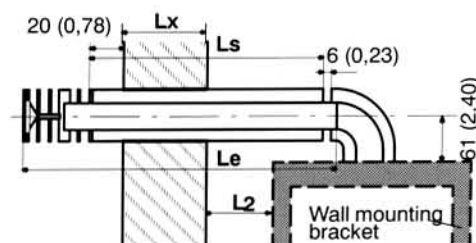

Mounting operations

- Insert the exhaust pipe into the suction pipe so that the wind-resistant terminal contacts the rim which is located on the inside of the suction pipe;

- introduce the pipe assembly, together with wind-resistant terminal, into the hole you have drilled in the wall. A 20 mm (0,78 ins) length of the suction pipe must protrude from the wall;
- mount the wall gaskets on the pipe;
- position the gaskets so when the pipe is pulled back they make good seal against the wall;

- insert the pipe support;
- insert the suction pipe on the tightening band;
- install the gasket which seals the elbow to the duct by placing the larger internal diameter of the gasket on the air suction pipe;

- place the gasket on the surface of the appliance;

- install the elbow on the support; be sure that the following conditions are met:
 make sure that the flue exhaust pipe is firmly inserted into the elbow;
 be sure that a distance of 6 mm (0,23 ins) has been left between the suction pipe and the elbow.
 The purpose of this space is to allow the elbow to be removed for maintenance after the pipe has been enclosed in the wall. Therefore, never push the suction pipe into the elbow;

- use the screws to attach the elbow to the surface of the appliance;
- use the gasket you previously installed to seal the connection between the elbow and the duct;
- use the gasket tightening band with springs and screws to tighten the gasket;
- make two $\varnothing 3,7$ mm (0,14 ins) holes; one on the elbow and the other on the intake pipe at the same level as the holes on the gasket tightening band;
- use the screws supplied with the kit to connect the elbow, the band and the pipe together.

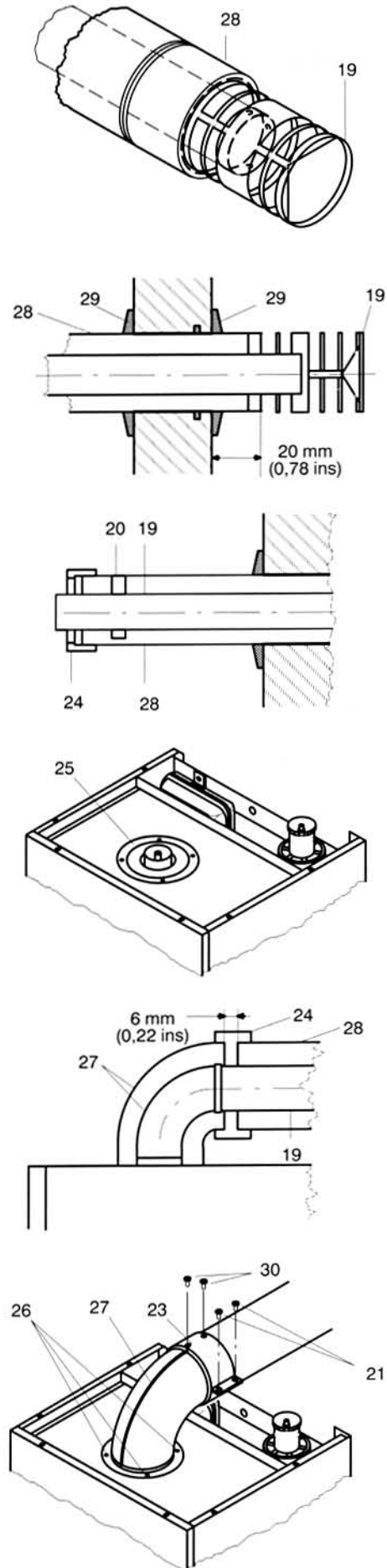

3.8 Flue terminal guard

Where codes of practise dictate a suitable guard should be fitted.
A suitable guard is available from:

TOWER FLUE COMPONENTS
Morley Road
Tonbridge
Kent TN9 1RA

When ordering guard, quote appliance model number.
The guard should be fitted centrally over the terminal.

3.9 Electrical connections

Connecting to the electricity supply

WARNING – THIS APPLIANCE MUST BE EARTHED

The appliance is delivered with a flexible cable for electrical supply.
The cable allows the electrical connection as detailed in sect. 2.8.

The electrical supply cable is stored inside the appliance in the lower right zone of the control panel and it is marked with a label stuck on its edge.

To gain access to the electrical supply cable, remove the front panel of the case, remove the lower protection plate and lower the control panel as explained in sect. 6.2.

- Pass the cables (electrical supply cable and external controls cable) through the rubber grommets fitted on the bracket indicated;
- make sure all cables to the appliance are detail route away from sharp edges and hot surfaces.
- fit the lower protection plate.

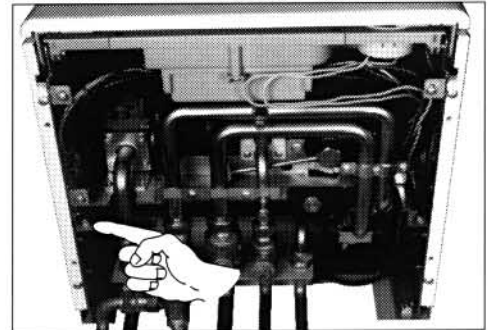

Replacing the electrical supply cable

To replace the electrical supply cable proceed as follows:

- remove the front panel of the case (sect.6.2)
- unscrew the four screws "A" and remove the service access door;
- loosen the screws "B" of the main terminal block (marked L and N) and the screw "C" of the earth terminal;
- loosen the screws "D" and pull the cable removing it from the clamp seat;
- remove the lower protection plate and lower the control panel (sect.6.2);

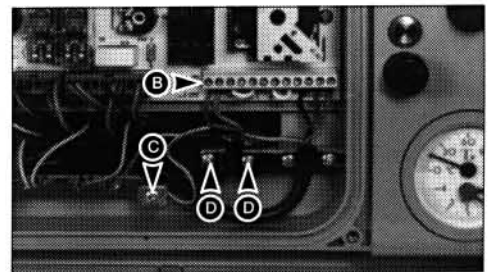
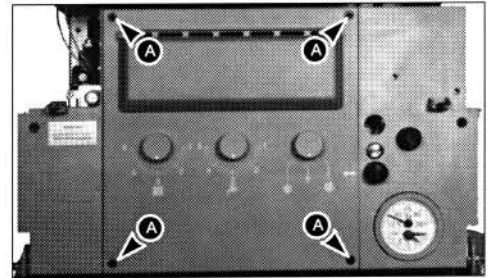

installation

- unscrew the four screws "E" and remove the cover on the full sequence control p.c.b.
- remove the cable sliding it through the rubber grommet "F";
- insert the new cable. A PVC insulated flexible cable must be used. It must be a 3 core of size 0.75 mm² (24x0.2 mm) to BS 6500 table 16;
- connect the cable to the terminals marked as follows:

Screws "B" $\left\{ \begin{array}{l} \text{L} - \text{Brown or Red wire (live)} \\ \text{N} - \text{Blue or Black wire (neutral)} \end{array} \right.$

Screw "C" \equiv Green/Yellow or Green wire (earth)

- The cable must be secured and connected so that should the cable slip from the anchorage the current carrying conductors become taut before the earthing conductor.

Connecting the external controls (room thermostat, timeclock)

WARNING – EXTERNAL CONTROL LINES MUST BE INSULATED FROM ELECTRICAL SUPPLY LINES.

If controls external to the appliance are required, design of the external electrical circuits should be undertaken by a competent person. It is essential that all external control circuits and wiring is wired from the same electrical isolator as serves the appliance. Factory fitted internal wiring must not be disturbed when wiring external controls.

To connect an external control:

- 1 remove the front panel of the case, remove the lower protection plate and lower the control panel (see sect. 6.2);
- 2 open the external control box removing the two screws indicated;
- 3 remove the electric link between TT and TC on the external control terminal block;
- 4 connect the external control as shown in the following figures.

If requested, external control must be earthed.

Timeclocks should be voltage free connections.

Connecting a "simple contact" room thermostat.

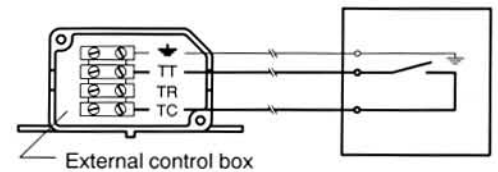
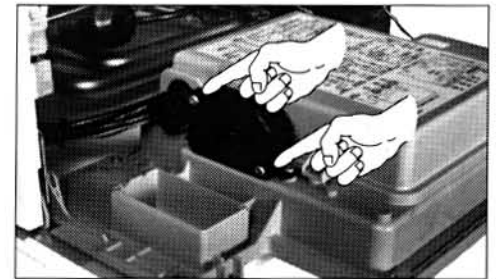
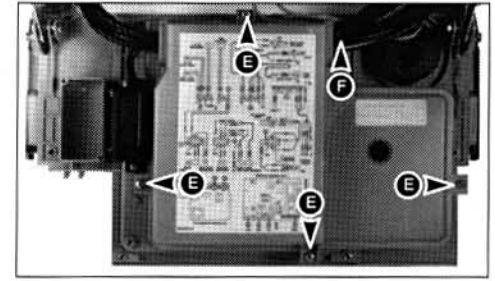

Connecting a room thermostat with delay resistor.

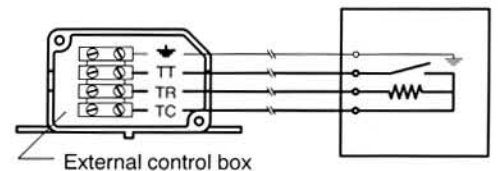

Connecting a timeclock.

**Do not insert any internal links on time locks.
Doing so may invalidate guarantee.**

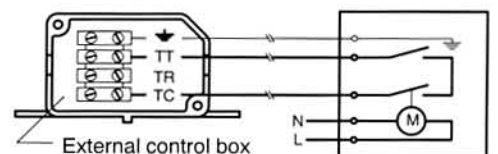

4 COMMISSIONING

4.1 Electrical installation

Preliminary electrical system checks to ensure electrical safety shall be carried out by a competent person. I.e. polarity, earth continuity, resistance to earth and short circuit.

If a fault has occurred on appliance the fault finding procedure should be followed as specified under the servicing section of this document.

4.2 Gas supply installation

- 1 Inspect the entire installation including the gas meter, test for soundness and purge, all as described in BS 6891;
- 2 open the gas cock (drawn with the knob in "open" position) on the appliance and check the gas connector on the appliance for leaks.

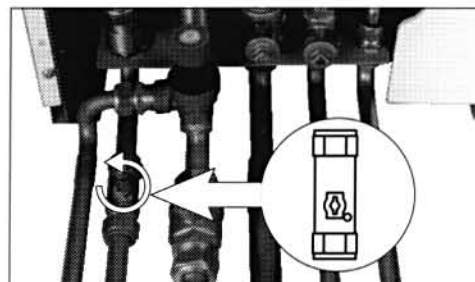

4.3 Filling the d.h.w. system

- 1 Close all hot water draw-off taps;
- 2 open the cold water inlet cock as indicated;
- 3 slowly open each draw-off tap and close it only when clear water, free of bubbles, flows out.

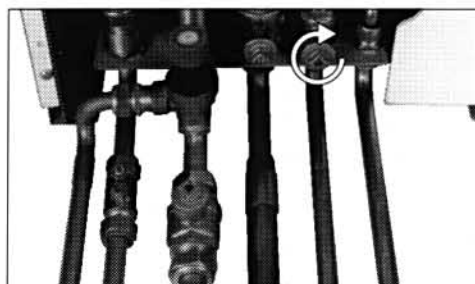

4.4 Initial filling of the system

- 1 Open central heating flow and return cocks as indicated;
- 2 unscrew the cap on the automatic air release valve one full turn and leave open permanently;
- 3 close all air release valves on central heating system;
- 4 gradually open stopcock at the filling point connection to the central heating system until water is heard to flow; do not open fully;
- 5 open each air release tap starting with the lower point and close it only when clear water, free of bubbles, flows out;
- 6 remove the front panel of the case, the lower protection plate and lower the control panel (sect. 6.2);
- 7 purge the air from the pump by unscrewing the pump plug indicated; release the pump by turning the rotor in the direction indicated by the arrow on the information plate;
- 8 close the pump plug;
- 9 continue filling the system until at least 1,5 bar (21,3 p.s.i.) registers on temperature-pressure gauge;
- 10 inspect the system for water soundness and remedy any leaks discovered.
- 11 make sure that the control lever on the 3-way valve (bottom side of appliance) is positioned to the right;

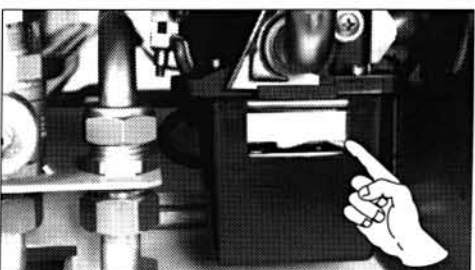
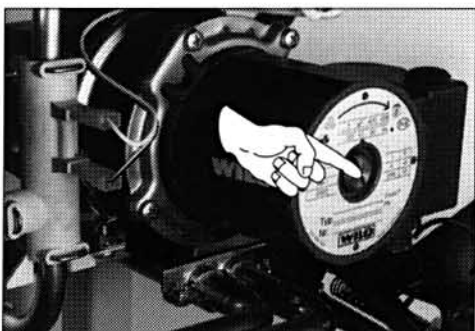
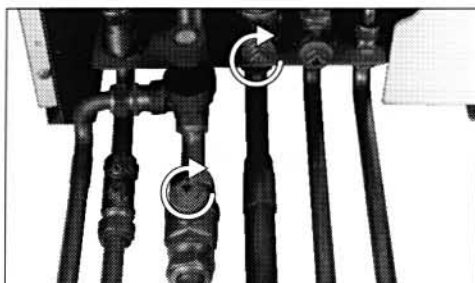

Commissioning

When the installation and filling are completed turn on the central heating system (sect. 4.6) and run it until the temperature has reached the boiler operating temperature. The system must then be immediately flushed through.

The flushing procedure must be in line with BS7593: 1992 *Treatment of Water in Domestic Hot Water Central Heating Systems*.

This procedure must be repeated twice more.

During this operation we highly recommend the use of a central heating flushing detergent, whose function it is to dissolve any foreign matter which may be in the system. i.e. Fernox Superfloc.

We also recommend the use of an inhibitor in the system such as Fernox MB1 universal.

The above operation could save the invalidation of your boilers guarantee and will also prevent problems which you may experience in the future if an inhibitor is not used.

4.5 Setting the system pressure

The actual reading should ideally be 1,5 bar (21,3 p.s.i.).

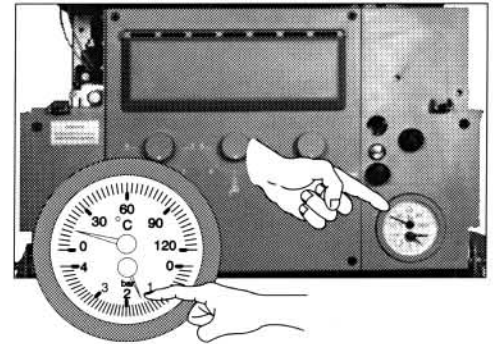

4.6 Lighting the boiler

If external controls are fitted (e. g. Timeclock, room thermostat) ensure they "call for heat".

Commissioning operations will be easier if controls are disconnected and terminals TT and TC are linked (see sect. 3.9).

- 1 Switch on the mains electricity and turn the function switch "A" as indicated.

The boiler will now go through an ignition sequence and the burner will light.

If during the ignition attempt period (4 secs. approx.) the boiler fails to light, the full sequence control p.c.b. will go to lockout and the shut-down warning light "B" will appear.

To reset the boiler depress the reset push button "C" marked with the symbol: 

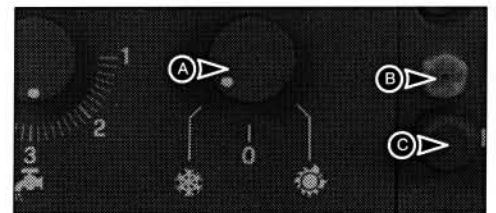

4.7 Checking the gas pressure at the burner

Checking maximum and minimum pressure levels

- 1 Remove the front panel of the case, the lower protection plate and lower the control panel (sect. 6.2);
- 2 remove the screw (indicated) on the pressure test point for measuring outlet pressure at the gas valve and fit a pressure gauge using a hose;
- 3 open the hot water tap fully;
- 4 turn the function switch as indicated;
- 5 set the d.h.w. temperature adjustment and the c.h. temperature adjustment to their maximum position;
- 6 check the maximum gas pressure and compare the value on the manometer with the values on sect. 1.2 (technical data) at page 2;
If the pressure is wrong it should be adjusted as instructed in sect. 6.5 at page 25;
- 7 check the maximum gas flow at the gas meter and compare with the values on sect. 1.2 (technical data) at page 2;
- 8 turn off the electricity supply;
- 9 disconnect the gas modulator removing a connector (indicated);
- 10 turn the function switch as shown at step 4;
- 11 check the minimum gas pressure and compare the value on the manometer with the values on sect. 1.2 (technical data) at page 2;
If the pressure is wrong it should be adjusted as instructed in section 6.5 at page 25;
- 12 switch off the appliance and re-connect the line to the gas modulator;
- 13 close the domestic hot water cock.

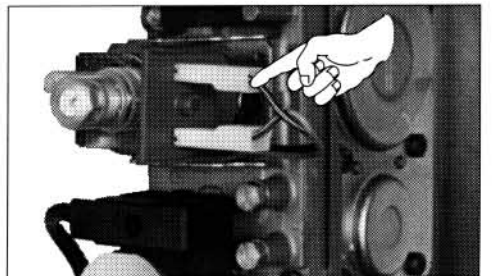
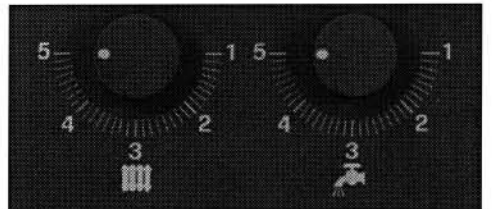
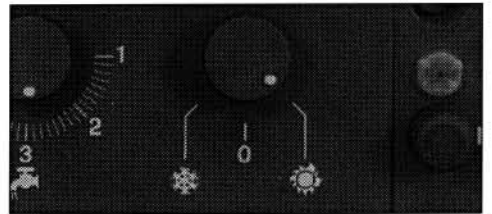
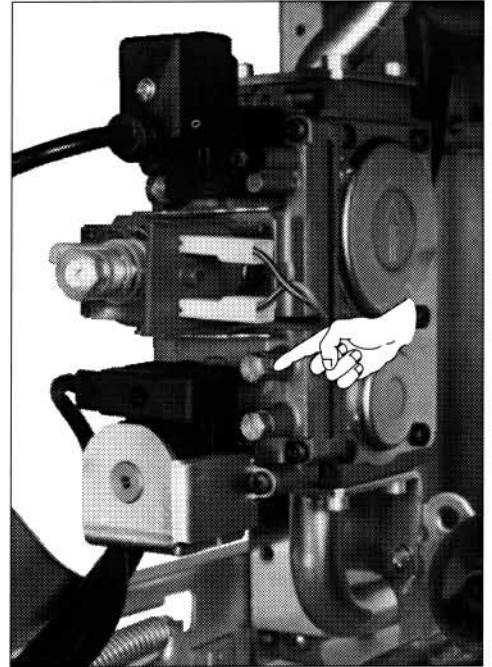

Commissioning

Checking the maximum rate for central heating

- 14 Turn the function switch as shown in sect. 4.6;
- 15 check the maximum gas pressure and refer to the diagram shown here to determine pressure for the heating output you need; If the pressure is wrong it should be adjusted as instructed in sect. 6.6 at page 25;
- 16 switch off the appliance;
- 17 securely close the pressure test point, close the control panel and fit the lower protection plate and the case.

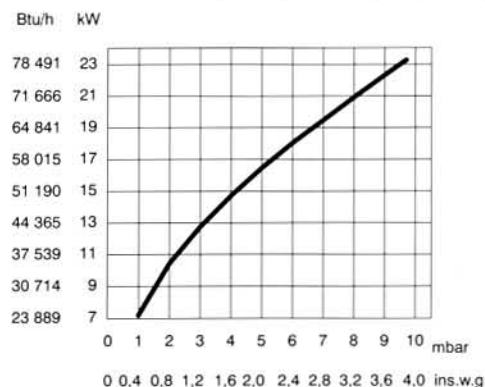

4.8 Checking the flue system

The flue system should be visually checked for soundness. Check all clamps, gaskets and fixings are secure and tight.

To check the exhaust gas, remove the screw indicated and connect the analyzer to the flue gas sampling point.

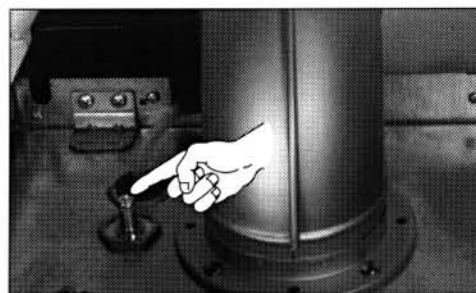

4.9 Checking the full sequence control

With the burner on high flame close the gas cock (drawn with the knob in "close" position) turning the screw in a clockwise direction; about 4 seconds after, the shut-down warning light must appear.

To reset the boiler depress the reset push button marked with the symbol:

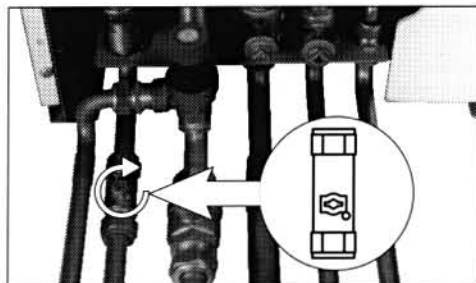

4.10 Testing the d.h.w. system flow

This appliance does not require particular regulations on d.h.w. function;

- 1 turn the function switch as indicated and check the switching flow rate that should be at minimum 2 lts/min (0,44 gals/min);

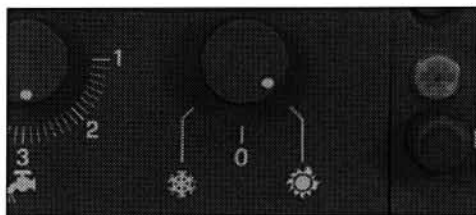

4.11 Selecting the pump operating modes

Three operating modes for the pump are available during c.h. operation.

These modes are selected by installing the electric link connection "A" between certain terminals on the main terminal block which is located on the electronic regulation p.c.b.

During d.h.w. heating operation the pump is activated automatically.

To gain access to the terminal block remove the front panel of the case and remove the service access door (sect. 6.2).

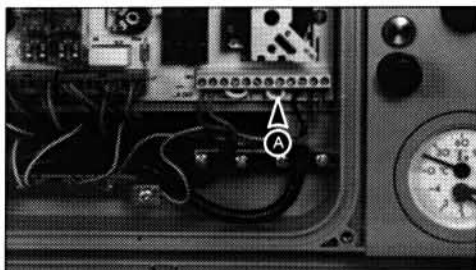

Commissioning

The pump may operate when activated by an external control device (room thermostat and/or timeclock).

This operating mode is obtained by connecting a link between terminals P2 and PC.

The appliance is tested and delivered in this operating mode

The pump may only operate when a request for heat lights up the main burner.

This operating mode is obtained by connecting a link between terminals P1 and PC.

The pump may continuously operate.

This operating mode is obtained by connecting a link between terminals P3 and PC.

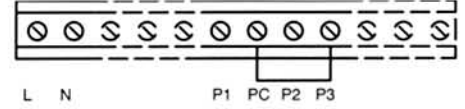
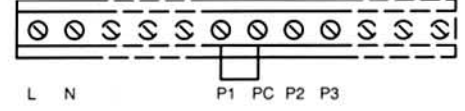
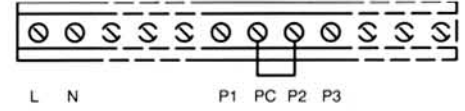

4.12 Instructing the user

- 1 Hand over the *User's guide* supplied with the appliance and explain how to use the unit in both c.h. and d.h.w. modes;
- 2 take the User step by step through the lighting instructions;
- 3 show the User how to switch off the appliance quickly and indicate the position of the electric supply isolator;
- 4 explain the proper use and adjustment of all system controls; this will ensure the greatest possible fuel economy;
- 5 explain the function and use of the function switch;
- 6 explain and demonstrate the function of time and temperature controls (if fitted);
- 7 explain how to turn off the appliance for both short and long periods and advise on the precautions necessary to prevent damage should the appliance be inoperative when freezing conditions may occur;
- 8 finally, advise the User that, for continued safe and efficient operation, the appliance must be serviced by a competent person at least once a year.

5 MAINTENANCE

5.1 General

To ensure efficient safe operation of the appliance it is necessary to carry out routine maintenance at regular intervals.

The frequency of servicing will depend upon the particular installation conditions and the use to which the boiler is put, but, in general, once per year should be adequate.

The following notes apply to the appliance but it should be remembered that attention must be also paid to the central heating and domestic hot water circuits with special attention to radiator valves, thermostats, clocks, leaking hot water taps etc.

WARNING

Before starting any servicing work, switch-off the electrical supply or disconnect the plug at the main isolating switch and socket (if a switch is used remove the fuse).

After any service on electrical components follow the instructions in the British Gas Multi Meter Book for preliminary electrical checks; in particular:

earth continuity;

polarity;

resistance to earth.

5.2 Recommended routine maintenance

The following procedures should be carried out at least once per year:

- 1 verify that the the electrical connections, the flue pipework and the case are in good conditions;
- 2 inspect ventilation arrangements as explained in section 2.5 to ensure no alterations have been made since installation;
- 3 switch-off the electrical supply and remove the the front panel of the case (section 6.2);
- 4 switch-on the electrical supply and run the boiler for few minutes in the d.h.w. mode;
- 5 check that the flame covers all the flame ports and is of a light blue colour. Yellow flames and excessive lifting of flames indicate poor combustion.

- 6 Visually check the flue system checked for soundness. Check all clamps, gaskets and fixings are secure and tight. To check the exhaust gas, remove the screw indicated in fig. 5.1 and connect the analyzer to the flue gas sampling point.

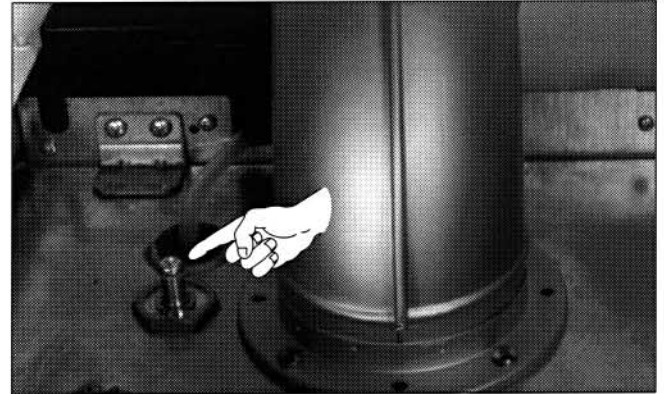

fig. 5.1

To inspect and clean the appliance

- 7 switch-off the electrical supply, remove the sealed chamber cover and open the combustion chamber (section 6.2);
- 8 if during initial check any combustion irregularity was suspected, remove the burner and the injectors (sections 6.10 and 6.11). Clean or replace if necessary;
- 9 inspect the main heat exchanger for any deposits of sooty. If cleaning is necessary place a cloth over the burner to catch debris and clean the main heat exchanger using a soft brush.
Do not use brushes with metallic bristles;
- 10 inspect the combustion chamber panels. If any panels are damaged these should be replaced;
- 11 examine the fan for any mechanical damage and check to ensure free running of the fan motor;
- 12 check sealing gaskets and replace if damaged;
- 13 replace all parts in reverse order with the exception of the case and the control panel;
- 14 undertake a complete commissioning check as detailed in section 4;
- 15 close-up the control panel and the case;
- 16 clean the case using a soft cloth.

6 SERVICING INSTRUCTIONS

6.1 Replacement of parts

The life of individual components varies and they will need servicing as and when faults develop.

The fault finding sequence charts in chapter 7 will serve to locate which component is the cause of any malfunction, and instructions for removal, inspection and replacement of the individual parts are given in the following pages.

6.2 To gain general access

All testing and maintenance operations on the water heater require the control panel to be lowered. These operations also require the removal of the panels which make up the case.

Removing the case

The front panel of the case is attached to the control panel by two screws.

To remove the front panel, proceed as follows:

- 1 remove the mounting screws indicated;
- 2 move the lower part of the front panel away from the unit;
- 3 raise the panel slightly and then remove it.

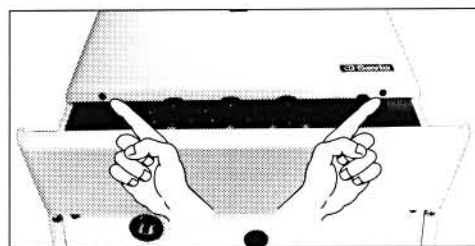

To remove the side panels remove the front panel as explained above, loosen the lower screws "A" and proceed in the same way as for the front panel.

Removing the lower protection plate

To remove the lower protection plate, loosen the screws "B" and move the plate toward the wall.

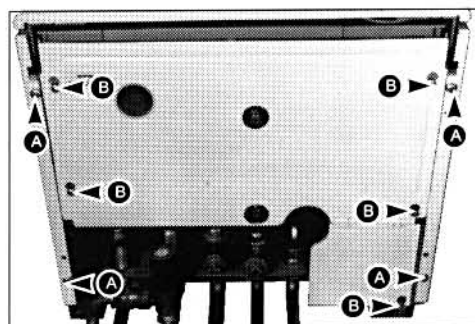

Lowering the control panel

The control panel is held in its normal position by two screws located on the left-hand and right-hand sides of the panel.

To lower the control panel proceed as follows:

- 1 remove the front panel of the case and the lower protection plate;
- 2 hold the control panel in position and remove the two screws indicated.
- 3 lower the panel.

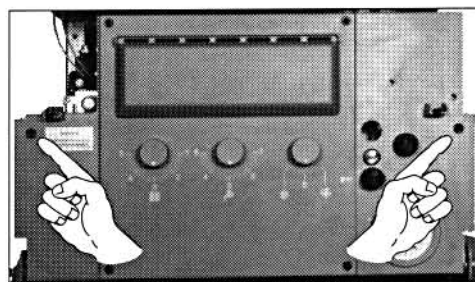

Removing the service access door

To remove the service access door proceed as follows:

- 1 remove the front panel of the case;
- 2 set the d.h.w temperature adjustment and the c.h. temperature adjustment to their maximum position;
- 3 set the function switch on "O" position;
- 4 unscrew the four screws "C" and remove the service access door;

Do not change position of knobs during service operations.

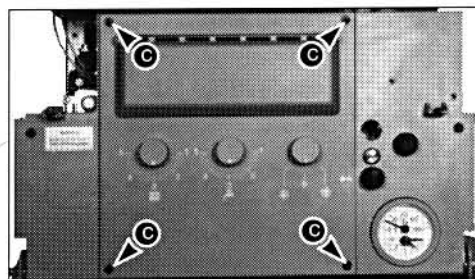

Servicing instructions

Removing the sealed chamber cover

To open the sealed chamber remove the front panel and the right panel of the case then turn the four clamps as indicated and remove the cover.

When replacing the sealed chamber cover ensure that the seal is made good. If adjustments is needed this can be done by adjusting the clamps.

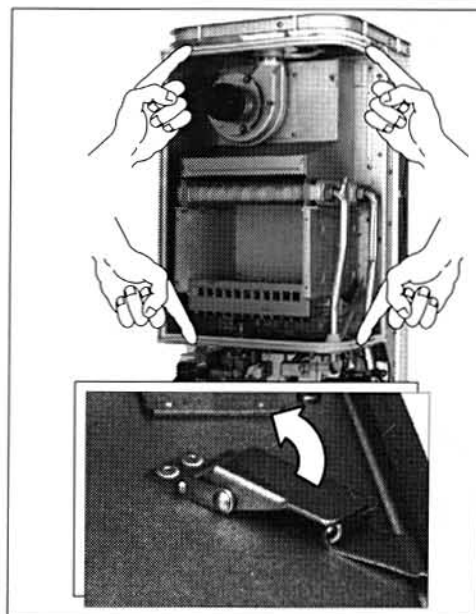

Opening the combustion chamber

- 1 Remove the four screws "D";
- 2 rise the panel and remove it.

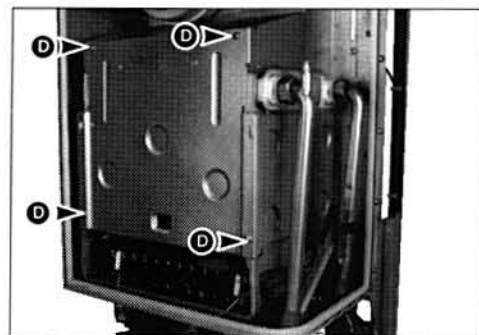

6.3 To drain the main circuit of the boiler

- 1 Close c.h. flow and return cocks;

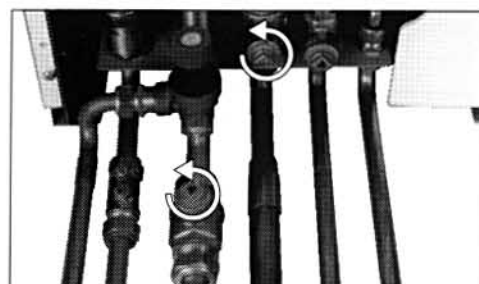

- 2 open the main circuit drainage cock indicated;
- 3 to speed drainage remove the front panel and the right panel of the case, the sealed chamber cover (sect. 6.2) and then open the manual vent cock placed near the main heat exchanger inlet connector.

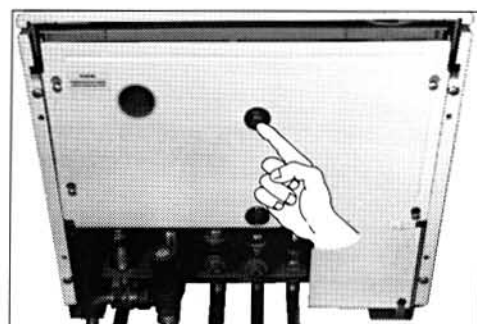

6.4 To drain the d.h.w. circuit of the boiler

- 1 Close the cold water inlet cock;
- 2 open the drain tap of d.h.w. system or a draw-off tap;
- 3 open the d.h.w. circuit drainage cock indicated.

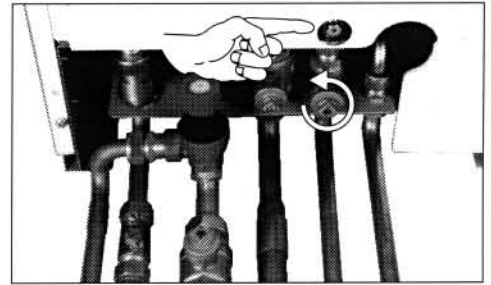

6.5 Setting gas pressures

IMPORTANT

minimum gas pressure must be set **after** maximum setting.

- 1 Open the boiler and operate as explained in sect. 4.7 from step 1 to step 5;

Setting the maximum gas pressure

- 2 turn the protective hood "A" counter-clockwise and remove it from the calibration system. Use a flat-edge screw driver to help removal;

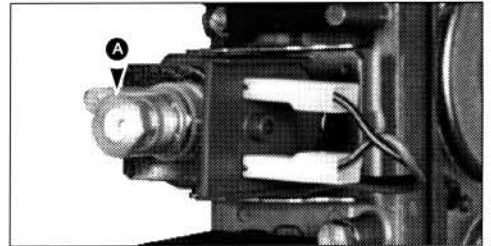

- 3 rotate adjustment control "B" to adjust the maximum gas pressure to the prescribed value. Rotate the control clockwise to increase the pressure.

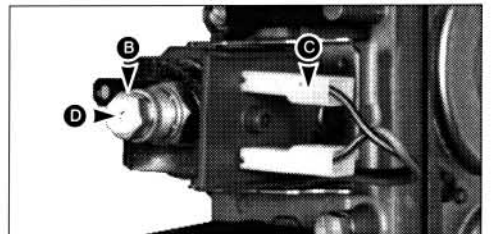

Setting the minimum gas pressure

- 4 Turn off the electrical supply;
- 5 remove the connector "C" to the gas modulator and make it safe;
- 6 turn on the electrical supply;
- 7 rotate adjustment control "D" to adjust to the minimum pressure prescribed value. Rotating the control clockwise increases the pressure;
- 8 make sure that both minimum and maximum gas pressures are correctly set by disconnecting and re-connecting the connector "C" to the gas modulator;
- 9 close the domestic hot water cock;
- 10 install the protective hood over the calibration system on the gas modulator;
- 11 **securely close the gas pressure test point**
- 12 close the appliance.

6.6 Reducing the maximum output to meet the central heating power requirements

- 1 Ensure electricity is switched off at main isolator;
- 2 turn the function switch as indicated;

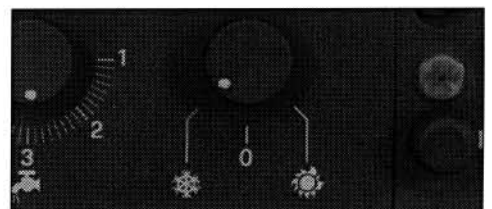

Servicing instructions

- 3 turn the c.h. temperature adjustment to its maximum position as indicated;
- 4 remove the service access door (sect. 6.2);
Do not change position of knobs during operations.



- 5 remove the lower protection plate and lower the control panel (sect. 6.2)
- 6 remove the screw on the pressure test point for measuring outlet pressure at the gas valve and fit a pressure gauge using a hose (step 2 at page 19);
- 7 switch on the main isolator;
- 8 using a screwdriver, gently adjust the regulation potentiometer on the electronic regulation p.c.b. for desired pressure; rotating the potentiometer counter-clockwise reduces the maximum current fed to the gas moulator and thus reduces the maximum gas pressure to the burner.

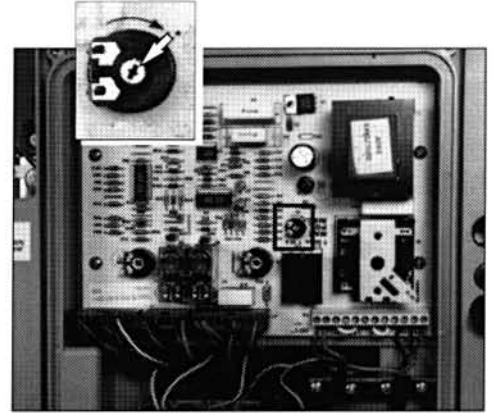

- 9 refer to the diagram shown here to determine pressure for the heating output you need;
- 10 **securely close the gas pressure test point.**
- 11 close the appliance;
- 12 reassemble protection plate and access door.

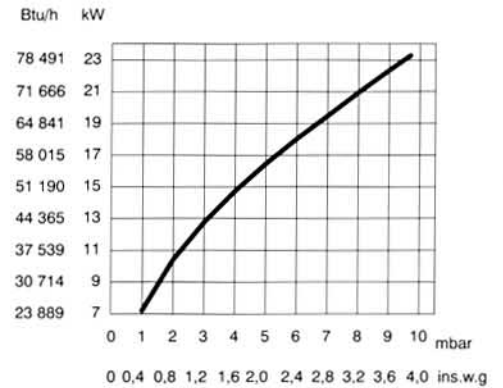

6.7 Electronic regulation p.c.b.

- 1 Ensure electricity is switched off at main isolator and remove the service access door (sect. 6.2);
- 2 disconnect the wires from the main terminal board "A".
- 3 disconnect the connectors "B";
- 4 loosen the screws "C" which hold the circuit board on the control panel;
- 5 remove the electronic regulation circuit board;
- 6 reassemble in reverse order.

To reassemble correctly the electric wires and connectors look at the wiring diagram in sect. 8.1 or at the diagram stuck on the inner cover of the control panel.

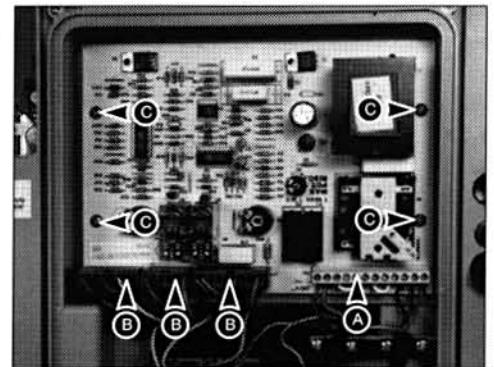

6.8 Full sequence control p.c.b.

- 1 Ensure electricity is switched off at main isolator;
- 2 remove the front panel of the case, the lower protection plate and lower the control panel (sect. 6.2);
- 3 remove the screws "A";
- 4 remove the cover on the full sequence control p.c.b. compartment;

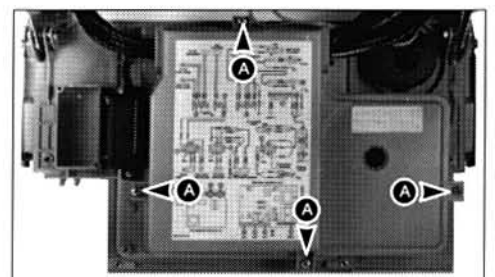

Servicing instructions

- 5 disconnect the electrical connectors "B";
- 6 remove the screw "C" which hold the electronic regulation p.c.b.;
- 7 remove the circuit board;
- 8 reassemble in reverse order.

To reassemble correctly the electric wires and connectors look at the wiring diagram in sect. 8.1 or at the diagram stuck on the inner cover of the control panel.

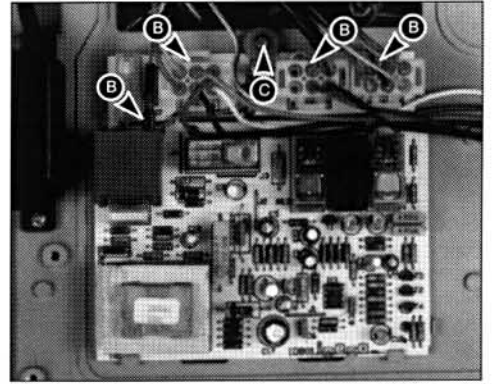

6.9 Overheat thermostat

- 1 Ensure electricity is switched off at main isolator;
- 2 remove the front panel and the right panel of the case; open the sealed chamber (sect. 6.2);
- 3 remove the spring indicated that holds the overheat thermostat probe;
- 4 remove the probe downward;

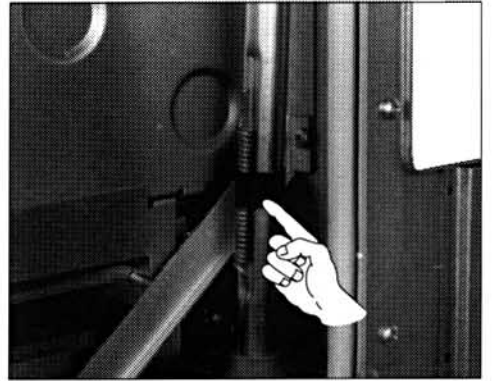

- 5 remove the lower protection plate and lower the control panel (sect. 6.2);
- 6 remove the cover on the full sequence control p.c.b. compartment;
- 7 disconnect the electrical connectors "A";

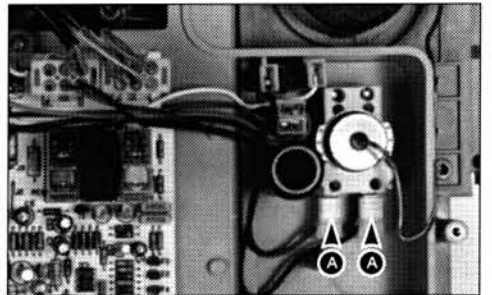

- 8 remove the protective cap on the overheat thermostat and remove the nut "B" (front view of the control panel);
- 9 remove the overheat thermostat;
- 10 reassemble in reverse order.

To reassemble correctly the electric wires and connectors look at the wiring diagram in sect. 8.1 or at the diagram stuck on the inner cover of the control panel.

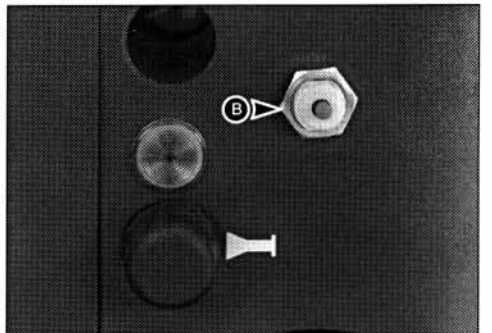

6.10 Burner

- 1 Ensure electricity is switched off at main isolator;
- 2 remove the front panel, the right panel, the sealed chamber cover and remove the combustion chamber cover (sect. 6.2);
- 3 disconnect the wires "A" from the ignition and detection electrodes;
- 4 remove the four screws placed at the right and left sides of the burner;
- 5 remove the burner;
- 6 reassemble in reverse order.

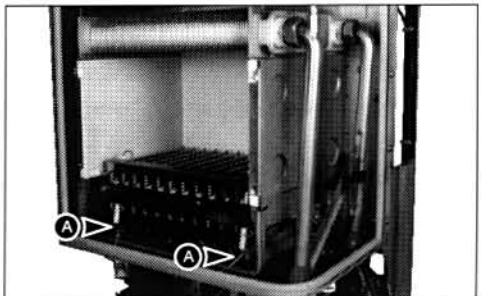

6.11 Injectors

- 1 Remove the burner (sect. 6.10);
- 2 unscrew injectors;
- 3 reassemble in reverse order.

Removing injectors, metallic gaskets must be replaced.

6.12 Ignition and/or detection electrodes

- 1 Remove the burner (sect. 6.10);
- 2 unscrew the screws "A" and remove the electrodes;
- 3 reassemble in reverse order.

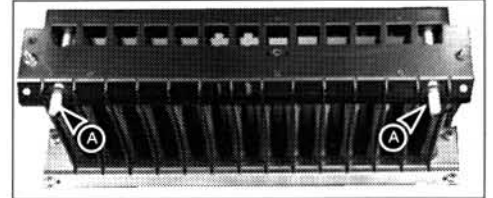

6.13 Insulation panels

To replace the front insulation panel

- 1 Remove the front panel, the right panel, the sealed chamber cover and remove the combustion chamber cover (sect. 6.2);
- 2 replace the combustion chamber cover with the insulation panel.

To replace the side insulation panels

- 1 Remove the front panel, the right panel, the sealed chamber cover and remove the combustion chamber cover (sect. 6.2);
- 2 disconnect the wires from the ignition and detection electrodes;
- 3 remove the grid sliding it toward the front of the appliance;
- 4 remove the main heat exchanger (sect. 6.20);
- 5 remove the screws "A" (the two at the right hand indicated) which hold the insulation panel supports to the frame and remove the supports;
- 6 replace the insulation panels;
- 7 reassemble in reverse order.

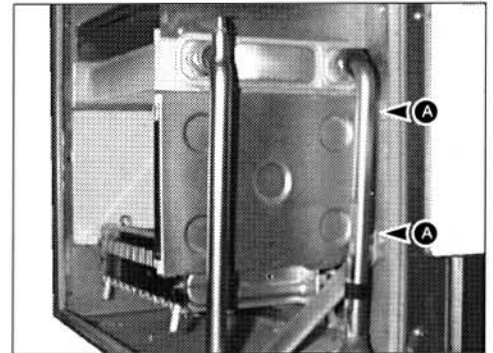

To replace the back insulation panel

- 1 Remove the front panel, the right panel, the sealed chamber cover and remove the combustion chamber cover (sect. 6.2);
- 2 remove the burner (sect. 6.10);
- 3 remove the main heat exchanger (sect. 6.20);
- 4 extract the spring "B" downwards;
- 5 remove the insulation panel;
- 6 reassemble in reverse order.

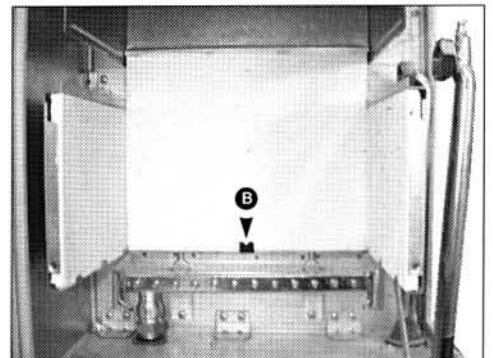

6.14 Gas modulator cartridge

- 1 Ensure electricity is switched off at main isolator;
- 2 remove the front panel of the case, the lower protection plate and lower the control panel (sect. 6.2);
- 3 turn the protection cap "A" and remove it from the adjustment control. Use a flat-edge screw driver to help removal;

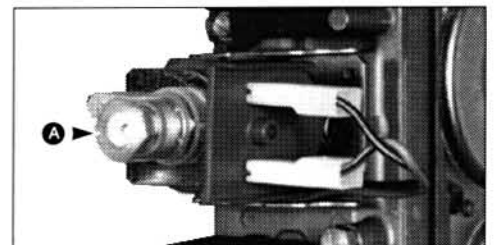

Servicing instructions

- 4 with a 14 mm spanner turn the cartridge "B" counter-clockwise;
- 5 remove the cartridge;
- 6 reassemble in reverse order.

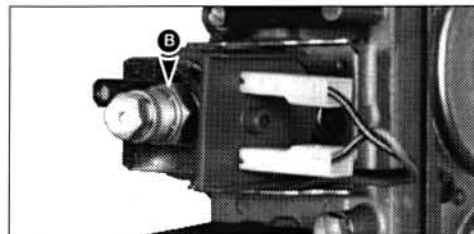

6.15 On-off operator coils

- 1 Ensure electricity is switched off at main isolator;
- 2 remove the front panel of the case, the lower protection plate and lower the control panel (sect. 6.2);

To remove the upper operator coil

- 3 loosen the screw "A" and remove the connector "B";
- 4 unscrew the screws "C" (the right one indicated) and slide the coil from the valve.
- 5 reassemble in reverse order.

To remove the lower operator coil

- 6 Remove the connector "D";
- 7 unscrew the screws "E" (the right one indicated) and slide the coil with its housing from the valve.
- 8 slide the coil from its housing;
- 9 reassemble in reverse order.

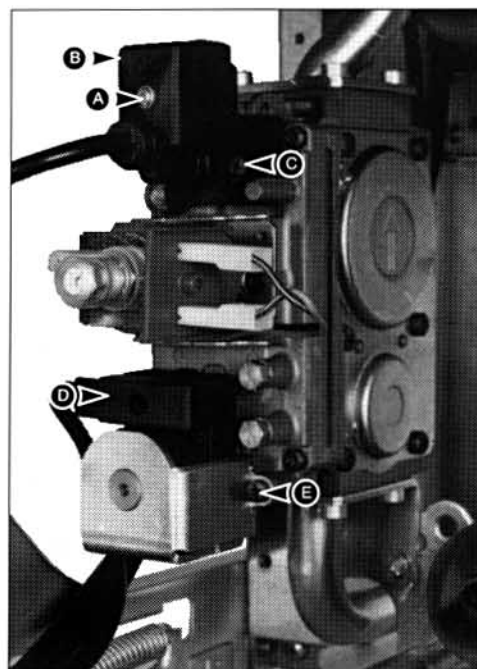

6.16 Gas modulator coil

- 1 Ensure electricity is switched off at main isolator;
- 2 remove the front panel of the case, the lower protection plate and lower the control panel (sect. 6.2);
- 3 remove the gas modulator cartridge as explained in sect. 6.14;
- 4 slide the coil "A" and its housing from the valve;
- 5 remove the plate "B";
- 6 slide the coil from its housing;
- 7 reassemble in reverse order.

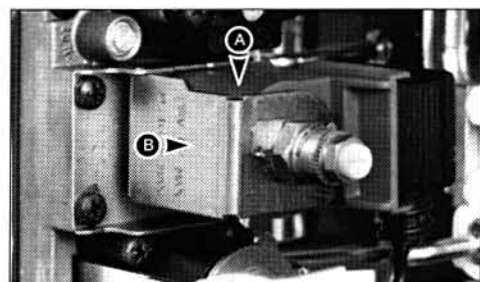

6.17 Gas valve

- 1 Ensure electricity is switched off at main isolator;
- 2 remove the front panel of the case, the lower protection plate and lower the control panel (sect. 6.2);
- 3 remove the connectors "A" to the gas modulator;
- 4 loose the screw "B" and remove the connectors "C" and "D" to the on-off operators;
- 5 completely unscrew the 7 grub-screws "E" and the hexagonal head screw "F" which join the gas valve to the flanges of the gas inlet and exit pipes;
- 6 remove the gas valve toward the front;
- 7 reassemble in reverse order.

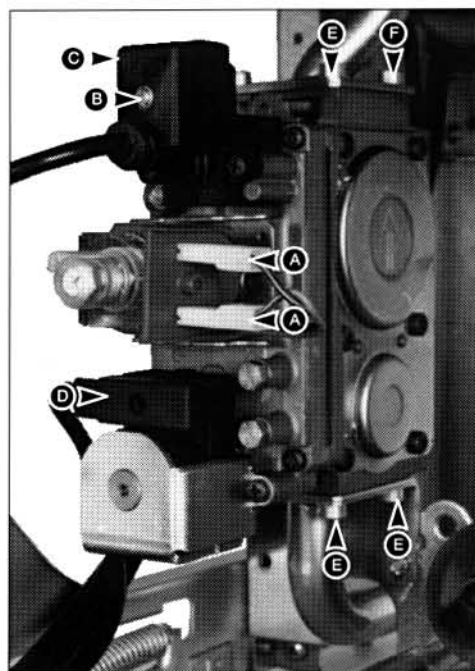

6.18 Fan and venturi device

- 1 Ensure electricity is switched off at main isolator;
- 2 remove the front panel and the right panel of the case; open the sealed chamber (sect. 6.2);
- 3 remove the connecting tubes "A" (to the flue gas sampling point) and "B" (to the air pressure switch);
- 4 disconnect the connectors "C";
- 5 remove the four screws "D" which hold the fan to the hood;
- 6 remove the fan by carrying it downwards.
The venturi device will descend along with the fan. Pull the venturi device in order to remove it from the fan.
- 7 reassemble in reverse order.

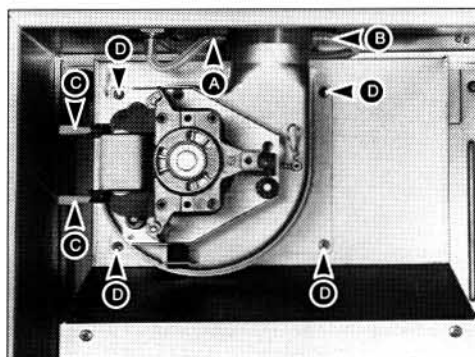

To reassemble correctly the electric wires and connectors look at the wiring diagram in sect. 8.1 or at the diagram stuck on the inner cover of the control panel.

Re-assembling the venturi device

- 1 Upside down the venturi device and insert the O-ring in the groove of the device;
- 2 hold the fan with its outlet downwards and insert the venturi device until the O-ring is pressed between the fan outlet and the device;
- 3 turn the venturi device as shown;
- 4 fit the cylindrical gasket "E" on the venturi device so that the lower side of the gasket leans on the upper step "F" of the venturi device.

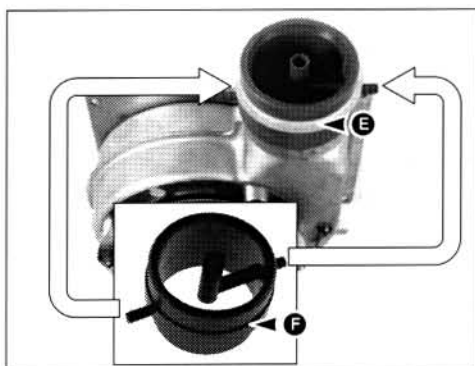

6.19 Air pressure switch

- 1 Ensure electricity is switched off at main isolator;
- 2 loosen the three screws "A" and open the box which houses the air pressure switch; this box is located on the upper left-hand side of the appliance;
- 3 disconnect the electrical connectors "B";
- 4 remove the connecting tube "C" which leads to the venturi device;
- 5 remove the air pressure switch;
- 6 reassemble in reverse order.

To reassemble correctly the electric wires and connectors look at the wiring diagram in sect. 8.1 or at the diagram stuck on the inner cover of the control panel.

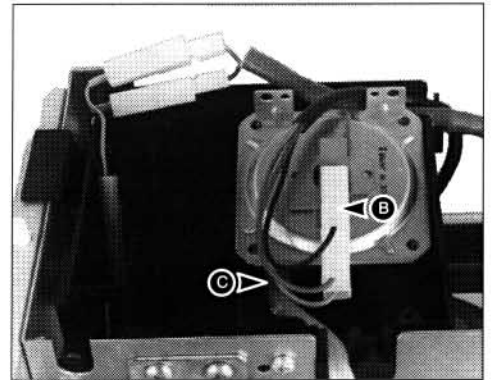
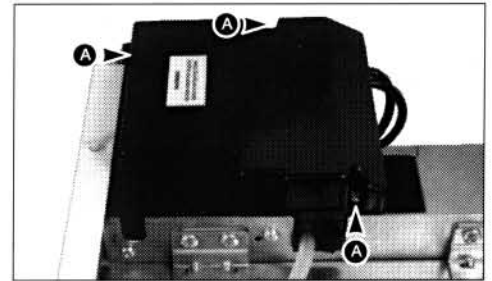

6.20 Main heat exchanger

- 7 Ensure electricity is switched off at main isolator;
- 8 remove the front panel and the right panel of the case, open the sealed chamber and the combustion chamber (sect. 6.2);
- 9 drain the main circuit (sect. 6.3);
- 10 unscrew the connections "A" on the inlet and outlet pipes;
- 11 remove the exchanger by pulling it toward the front of the appliance;
- 12 reassemble in reverse order.

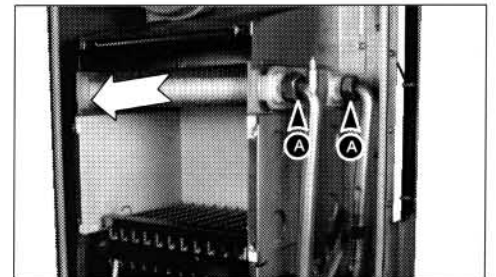

6.21 Main circuit temperature probe

- 1 Ensure electricity is switched off at main isolator;
- 2 remove the front panel and the right panel of the case (sect. 6.2);
- 3 drain the main circuit of the boiler (sect. 6.3);
- 4 slide the rubber hood (not shown) which protects the probe;
- 5 remove the connector indicated;
- 6 unscrew main circuit temperature probe from its pipe;
- 7 remove it;
- 8 reassemble in reverse order.

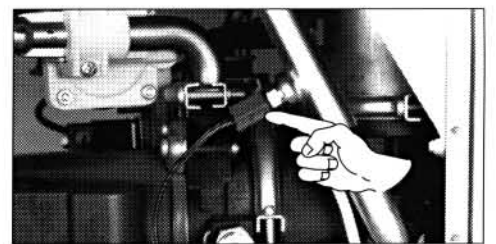

6.22 Pump

- 1 Ensure electricity is switched off at main isolator;
- 2 remove the front panel and the right panel of the case, remove the lower protection plate and lower the control panel (sect. 6.2);
- 3 drain the main circuit of the boiler (sect. 6.3);
- 4 open cover "A" which protects the electrical terminals and disconnect the electrical power cables and the earth cable from the pump;
- 5 remove the four screws indicated with a circle which attach the pump to the volute (scroll);
- 6 remove the pump.

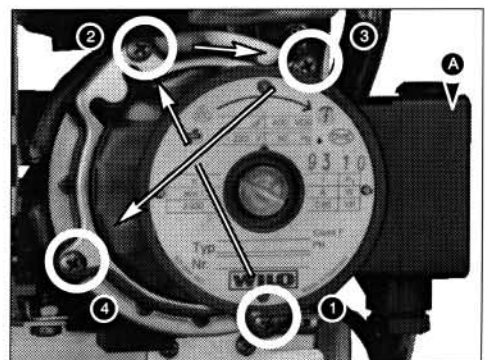

Servicing instructions

Re-assembling the pump

- 1 Carefully clean the supporting seat for the flat gasket;
- 2 correctly position the gasket in the seat on the volute (scroll);
- 3 correctly position the pump and the mounting flange;
- 4 insert the four mounting screws;
- 5 tighten the four screws until they meet resistance but do not allow the screws to exert any uneven pressure whatsoever on the flange;
- 6 tighten down the four mounting screws completely in the sequence shown in the figure.

Do not overtighten screws;

- 7 connect the electrical power cables to the pump.

To reassemble correctly the electric wires and connectors look at the wiring diagram in sect. 8.1 or at the diagram stuck on the inner cover of the control panel.

6.23 Main circuit flow switch

- 1 Ensure electricity is switched off at main isolator;
- 2 remove the front panel and the right panel of the case, remove the lower protection plate and lower the control panel (sect. 6.2);
- 3 drain the main circuit (sect. 6.3);
- 4 completely loosen the two screws "A";
- 5 remove the cover "B" which protects the microswitch;
- 6 disconnect the electrical connections;

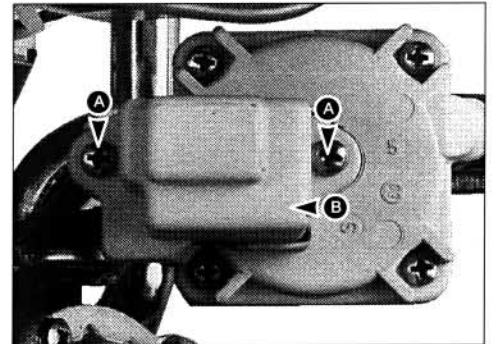

- 7 loosen the two screws "C" which attach the flow switch to the pipe;
- 8 remove the flow switch;
- 9 reassemble in reverse order.

When replacing the flow switch, be sure to pay attention to the reference notch on the body of the flow switch; this notch must be lined up with a similar notch on the pipe.

To reassemble correctly the electric wires and connectors look at the wiring diagram in sect. 8.1 or at the diagram stuck on the inner cover of the control panel.

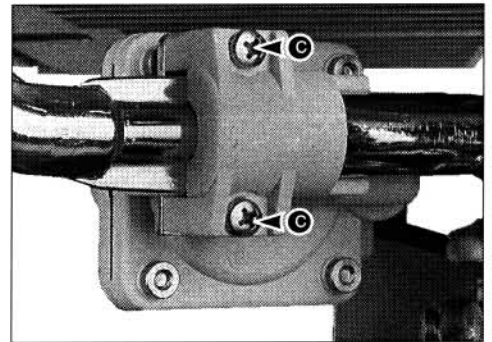

6.24 Pump pressure switch

- 1 Ensure electricity is switched off at main isolator;
- 2 remove the front panel of the case, the lower protection plate and lower the control panel (sect. 6.2);
- 3 drain the main circuit (sect. 6.3);
- 4 remove the protective cap on the pump pressure switch;
- 5 disconnect the electrical connections;
- 6 with a suitable fork spanner unscrew the pump pressure switch and remove it;
- 7 reassemble in reverse order.

To reassemble correctly the electric wires and connectors look at the wiring diagram in sect. 8.1 or at the diagram stuck on the inner cover of the control panel.

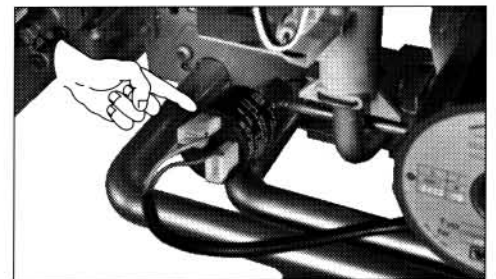

6.25 Temperature–pressure gauge

- 1 Ensure electricity is switched off at main isolator;
- 2 remove the front panel and the right panel of the case, remove the lower protection plate and lower the control panel (sect. 6.2);
- 3 drain the main circuit (sect. 6.3);
- 4 with a suitable fork spanner hold the connector "A" and unscrew the nut "B" removing the pressure gauge pipe;
- 5 remove thermometer bulb "C" from the outlet pipe on the main heat exchanger;
- 6 remove the temperature–pressure gauge from the control panel by pressing on the elastic splines "D" which hold it in position;
- 7 reassemble in reverse order.

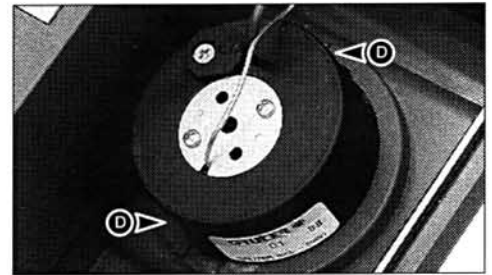
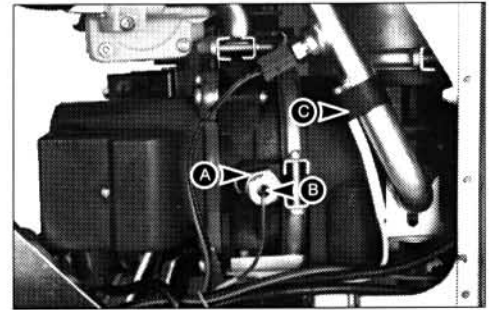

6.26 By-pass

- 1 Ensure electricity is switched off at main isolator;
- 2 remove the front panel of the case, the lower protection plate and lower the control panel (sect. 6.2);
- 3 drain the main circuit (sect. 6.3);
- 4 remove fork "A" (back view) which holds the by-pass to the water deviation body;
- 5 remove the by-pass from the water deviation body.

The by-pass has a profiled internal element: when assembling the by-pass, the two flat surfaces must be positioned horizontally.

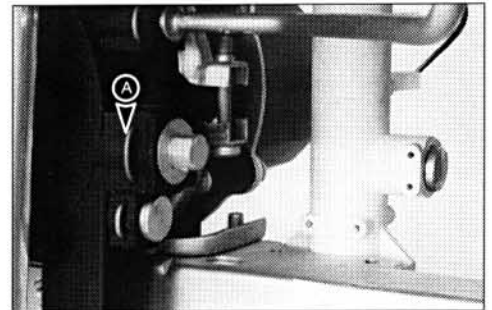

6.27 Automatic air release valve

- 1 Ensure electricity is switched off at main isolator;
- 2 drain the main circuit (sect. 6.3);
- 3 remove the valve by hand unscrewing it;
- 4 reassemble in reverse order.

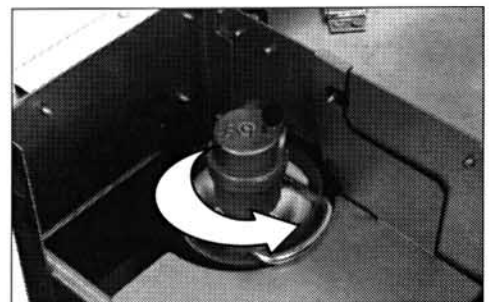

6.28 Expansion vessel

- 1 Ensure electricity is switched off at main isolator;
- 2 remove the front panel and the left panel of the case, the lower protection plate and lower the control panel (sect. 6.2);
- 3 drain the main circuit (sect. 6.3);
- 4 completely loosen the lower connector indicated which connects the expansion vessel to the appliance;

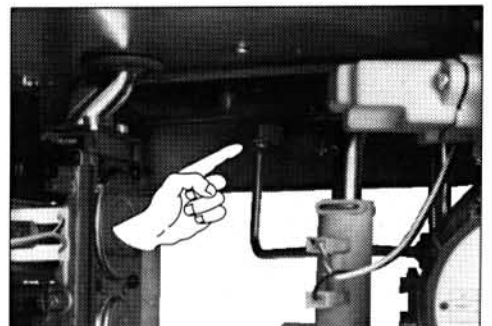

Servicing instructions

- 5 remove the upper protection plate by loosening the screw "A" which holds the plate to the chassis;
- 6 remove the screws "B" and move the box containing the air pressure switch toward the front of the appliance;
- 7 remove the upper bolt which attaches the expansion vessel to the transverse bar on the chassis;
- 8 remove the expansion vessel from above;
- 9 reassemble in reverse order.

N.B. – on a rear flue installation or where the access is limited the boiler must be removed from the wall.

Checking the expansion vessel pressure

- 1 Remove the front panel of the case, the lower protection plate and lower the control panel (sect. 6.2);
- 2 remove the plug indicated and check the expansion vessel pressure

The expansion vessel is normally pressurized to 0.7 bar (10,1 p.s.i.).

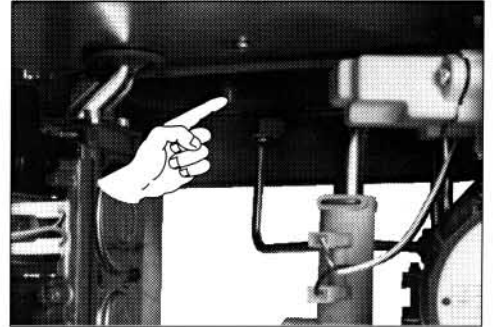
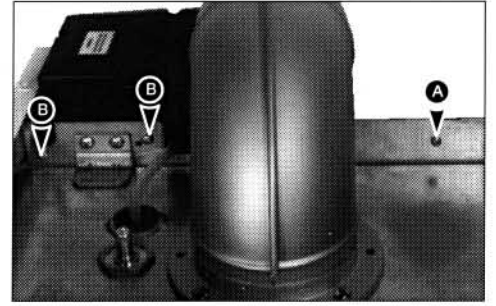

6.29 Safety valve

- 1 Unscrew the connectors "A" and remove the valve;
- 2 remove the nipple "B" from the valve;
- 3 reassemble in reverse order.

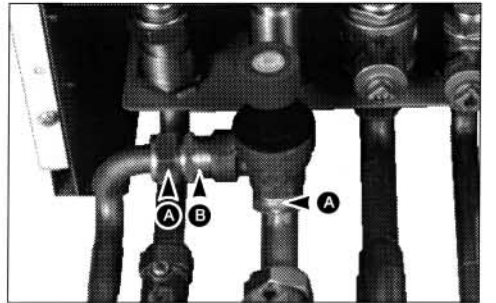

6.30 3-way valve

- 1 Remove the water unit from the appliance (sect. 6.34);
- 2 move lever "A" to the "manual" position;
- 3 completely loosen the screw "B" and remove the cover from the 3-way valve;
- 4 disconnect the electrical connections (both power and ground connections);
- 5 remove the four screws "C" which hold the valve to the water deviation body;
- 6 reassemble in reverse order.

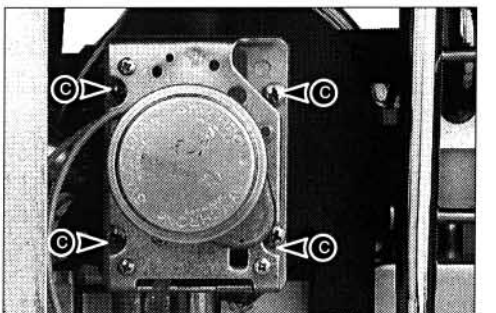
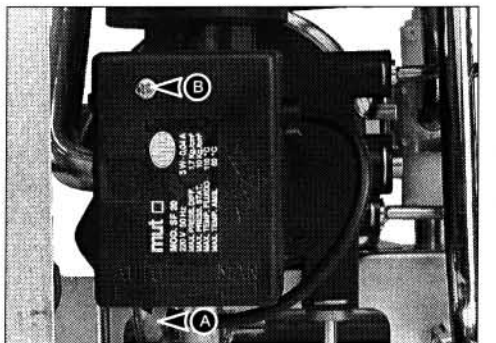

6.31 D.h.w. heat exchanger

The d.h.w. heat exchanger may be carried out in two ways, according to the manner in which the appliance is installed:

- from the top if at least 40 cm (15,7 ins) of free space are available between the appliance and any obstacle above the appliance;
- toward the side (right-hand side) if at least 13 cm (5,1 ins) of free space are available between the appliance and any obstacle to the right side.

- 1 Ensure electricity is switched off at main isolator;
- 2 remove the front panel and the right panel of the case, lower the control panel and the sealed chamber (sect. 6.2);
- 3 drain the main and d.h.w circuits (sects. 6.3 and 6.4);
- 4 remove the upper protection plate by loosening the screw "A" which holds the plate to the chassis;

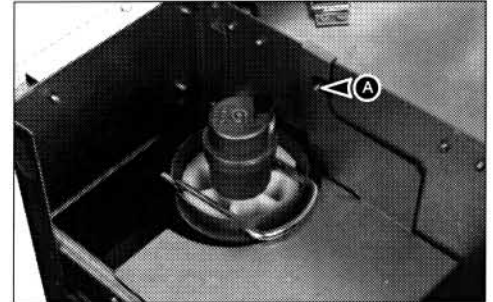

- 5 remove the upper bracket by loosening the screw "B" which holds the bracket to the chassis;

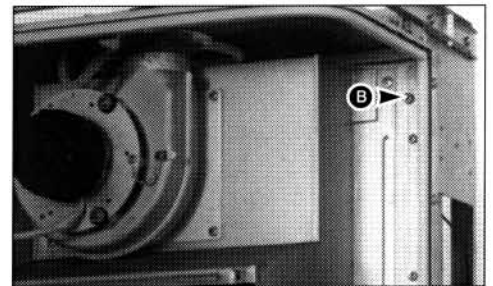

- 6 disconnect the d.h.w. outlet "C";

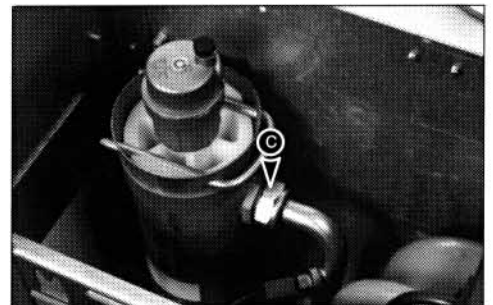

- 7 disconnect the water inlet connector "D";
- 8 remove the collars which join the heat exchanger to the water deviation body by completely loosening the screws "E";
- 9 remove the exchanger;
- 10 ensure the internal conveyor is lifted clear off the water deviator and retrieve the O-ring;
- 11 reassemble in reverse order.

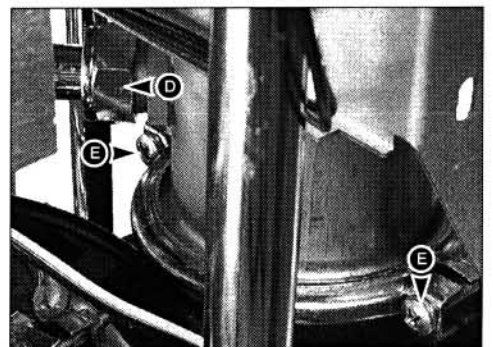

When replacing the d.h.w. heat exchanger, be sure to pay attention to the reference notch on the lower edge of the exchanger shell; this notch must be lined up with a similar notch on the water deviation body.

Care should be taken to ensure that the O-ring remains in position when reassembling.

Servicing instructions

Removing the plug

- 1 Remove the d.h.w. heat exchanger;
- 2 slacken the automatic air release valve
- 3 remove the fork;
- 4 use a screwdriver to pry between the shell and the air release valve at a number of different points;
- 5 lift the plug and the valve upwards.

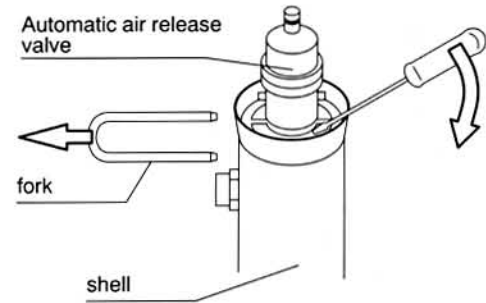

Installing the plug

- 1 Install O-rings "A" and "B" on the grooves in the plug;
- 2 install O-ring "C" into the upper flaring of the bellows;
- 3 insert the plug by rotating it until the fork can be installed;
- 4 insert the fork "D".

To reassemble correctly the O-rings look at the diagram in sect. 6.35 at the end of this chapter.

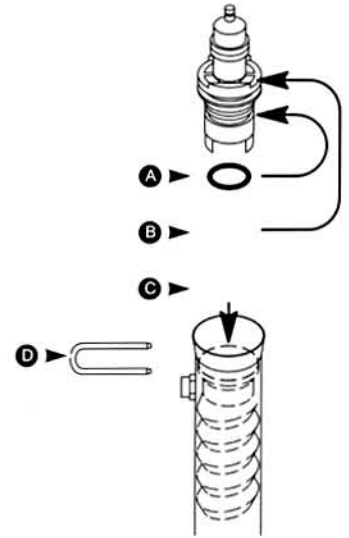

Disassembling the d.h.w. heat exchanger

- 1 Remove the d.h.w. heat exchanger from the appliance;
- 2 remove the internal conveyor "A";
- 3 remove the plug as previously explained;
- 4 remove the O-rings from the plug;
- 5 use the plug to push the bellows from the bottom of the shell;

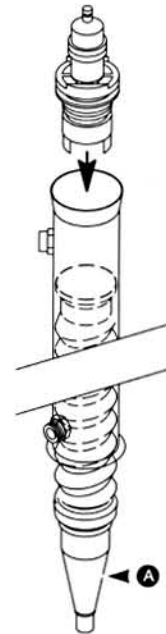

Servicing instructions

Re-assembling the d.h.w. heat exchanger

- 1 Position the O-ring gaskets on the lower end of the bellows;
- 2 insert the bellows into the shell and use the plug, without O-rings, to force the bellows into its final position;
- 3 install the plug as previously explained;
- 4 install the internal conveyor with the conical edge toward the bottom of the shell.

To reassemble correctly the O-rings look at the diagram in sect. 6.35 at the end of this chapter.

Important

Avoid deformation of the bellows to assure proper sealing by the O-ring gaskets.

Assembling the d.h.w. exchanger in the appliance the lower O-ring must remain on the edge of the bellows.

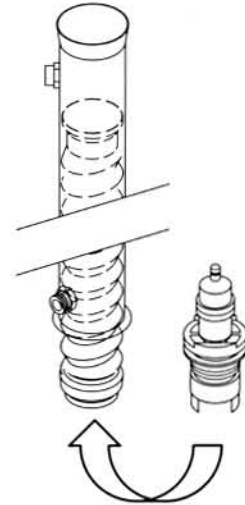

6.32 D.h.w. temperature probe

- 1 Ensure electricity is switched off at main isolator;
- 2 drain the d.h.w circuit (sect 6.4);
- 3 remove the upper protection plate by loosening the screw "A" which holds the plate to the chassis;

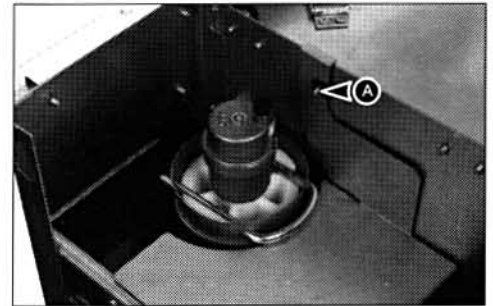

- 4 remove the rubber hood (not shown) which protects the probe;
- 5 disconnect the electrical cables from the d.h.w. temperature probe "B";
- 6 unscrew d.h.w. temperature probe from its pipe;
- 7 remove it;
- 8 reassemble in reverse order.

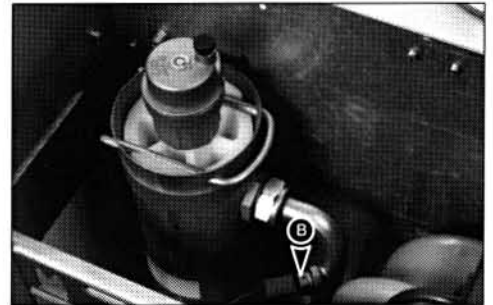

6.33 D.h.w. flow switch

Two types of basic maintenance are prescribed for this flow switch:

- Cleaning of the filter and/or insertion of the flow limiter;
- Complete substitution of the flow switch.

Cleaning of the filter

- 1 Ensure electricity is switched off at main isolator;
- 2 remove the front panel of the case, the lower protection plate and lower the control panel (sect. 6.2);
- 3 drain the d.h.w circuit (sect 6.4);
- 4 completely loosen the inlet connector to the d.h.w. circuit;
- 5 remove the pipe support spline by loosening the screw "A" which holds the spline to the bracket;
- 6 remove the lower fork "B" on the flow switch;
- 7 remove inlet pipe "C" by gently pulling it downwards;
- 8 reassemble in reverse order.

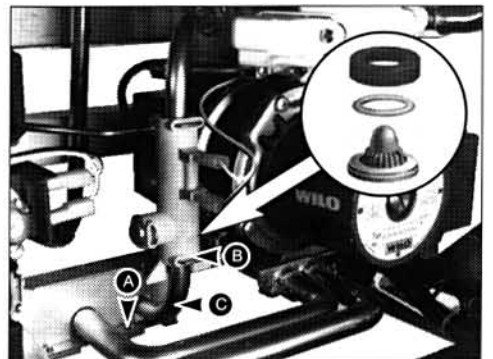

When re-assembling this unit, make sure that flow limiter is installed as shown.

Servicing instructions

Complete substitution of the flow switch

- 1 Ensure electricity is switched off at main isolator;
- 2 remove the front panel of the case, the lower protection plate and lower the control panel (sect. 6.2);
- 3 drain the d.h.w circuit (sect 6.4);
- 4 remove the connectors "A";
- 5 completely loosen the inlet connector for the d.h.w. circuit;
- 6 remove the pipe support spline by loosening the screw "B" which holds the spline to the bracket;
- 7 completely loosen the connector which connects the flow switch to the d.h.w. heat exchanger;
- 8 remove the screws "C" that hold the flow switch to the bracket;
- 9 remove the d.h.w. flow switch;
- 10 reassemble in reverse order.

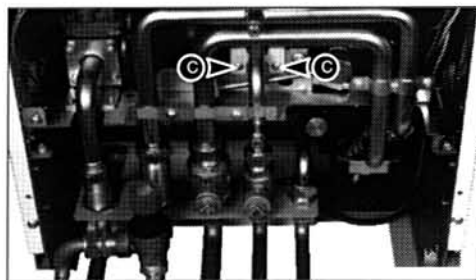
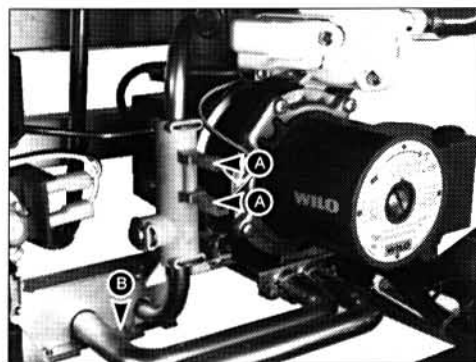

6.34 Water unit

The water unit is an assembly of components which can be removed from the appliance as a single unit.

The unit is made up of the pump, volute (scroll), water deviation body, heating water filter, 3-way valve, by-pass, d.h.w flow switch and the heating water flow and return pipes.



- 1 Ensure electricity is switched off at main isolator;
- 2 remove the front panel and the right panel of the case; open the sealed chamber; remove the lower protection plate and lower the control panel (sect. 6.2);
- 3 remove the d.h.w. heat exchanger as explained in sect. 6.31;
- 4 remove connection collar "A" on the outlet from the volute (scroll);
- 5 loosen the connector on the expansion vessel "B"
- 6 remove the fork which holds the pipe to the water unit and remove the pipe;

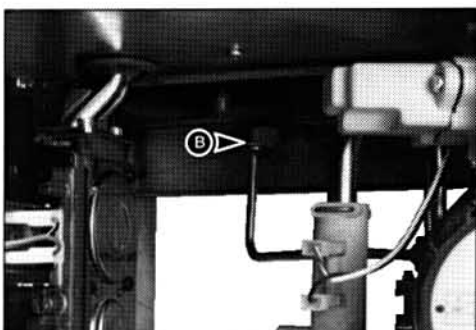
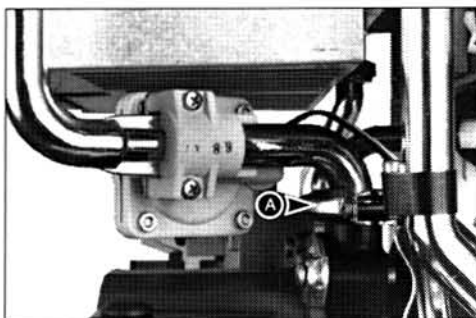

Servicing instructions

7 loosen the outlet connector of the main heat exchanger;

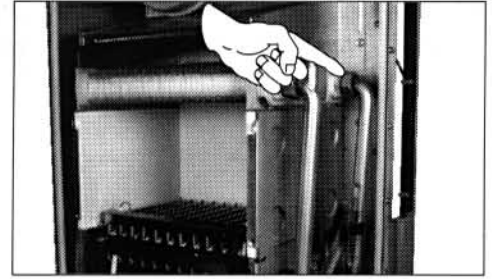

8 remove fork "C" which holds the connecting pipe to the main heat exchanger and move the pipe away from the water deviation body;

9 disconnect the pressure gauge connecting pipe by removing the fork "D" which attaches the pipe to the volute (scroll);

10 remove the cable ties;

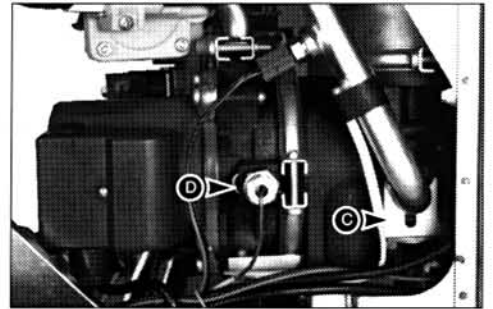

11 slide the rubber hoods and disconnect the electric connector "E";

12 disconnect the connectors on the d.h.w. flow switch and slide the cable away from the water unit;

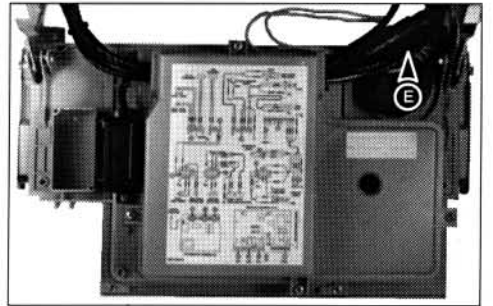

13 remove the protective cap on the pump pressure switch and disconnect it;

14 completely loosen the three connectors "F" (c.h. return, c.h. flow, d.h.w. inlet);

15 remove the two screws "G" which attach the support bracket for the water unit to the chassis;

16 keep the cables away from the unit and gently lift the water unit to release it from the chassis;

17 remove the water unit downwards;

18 reassemble in reverse order.

To reassemble correctly the electric wires and connectors look at the wiring diagram in sect. 8.1 or at the diagram stuck on the inner cover of the control panel.

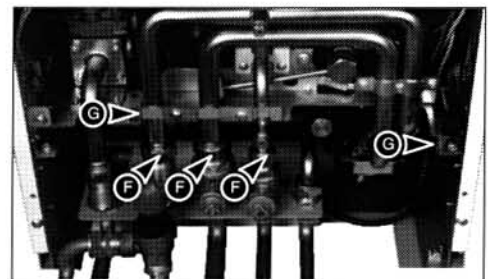

6.35 O-rings position on the d.h.w. heat exchanger

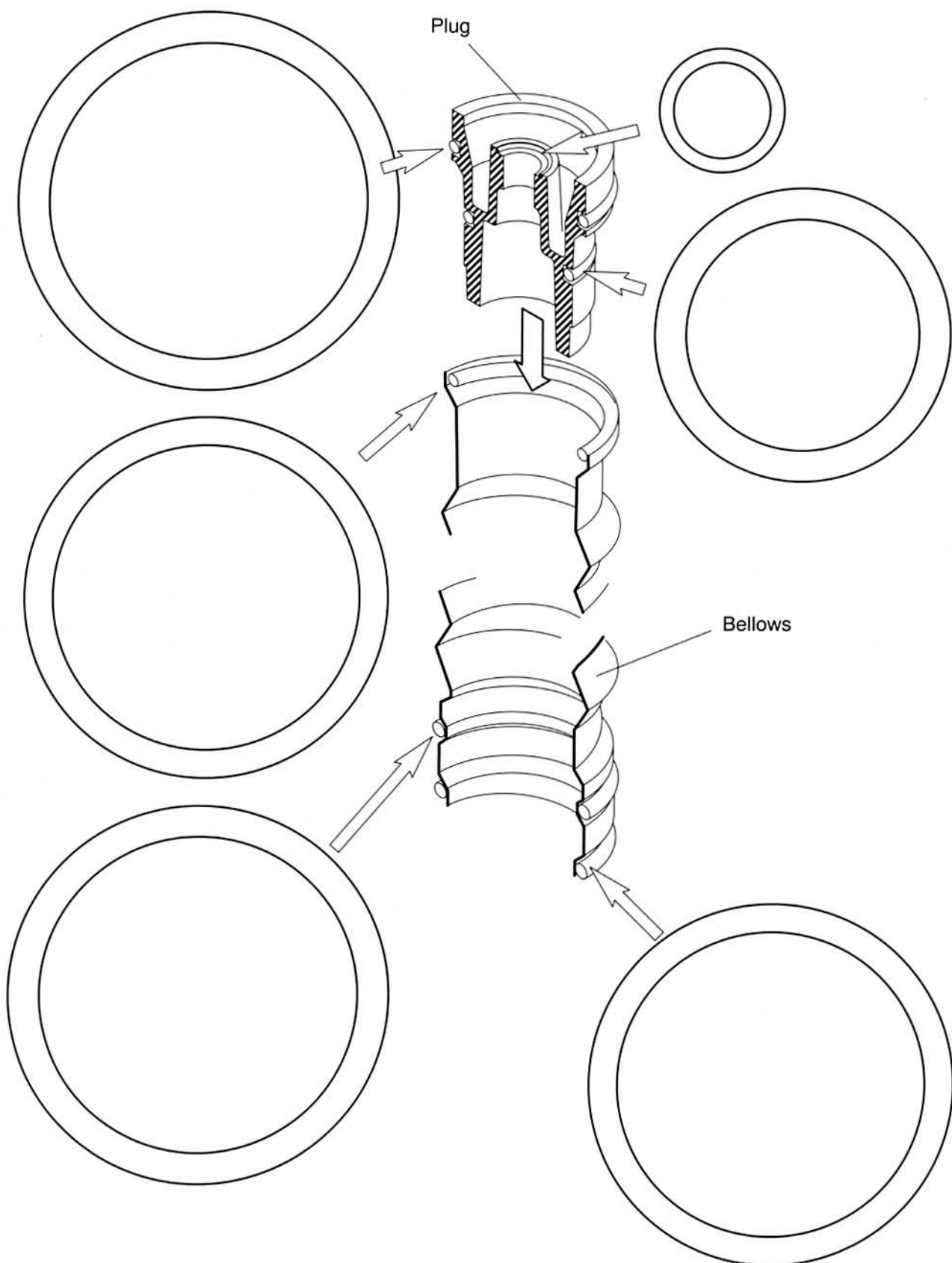

All O-rings are illustrated in real size

7 FAULT FINDING

7.1 Fault finding diagrams

The fault finding diagrams illustrate the proper steps to be followed when searching for the cause of improper operation.

Even though the diagrams refer to four specific cases, they can be used to diagnose most causes of improper operation.

The functions carried out by all components in the appliance are illustrated; this method of component illustration allows most cases of improper operation to be corrected.

However, a malfunction may occur which cannot be troubleshooted from the diagrams. In this case see section 7.3 and the paragraphs which follow it.

7.2 Using the fault finding diagrams

Each diagram is developed on two sides: a flow chart of the operating logic of the appliance is printed on the left, while additional details concerning the flow chart are printed on the right.

The questions which follow the start point (located inside a rhomb) must be answered by YES or NO according to a test carried out on the appliance. Each YES or NO answer leads to a specific path in the fault finding process, and each path eventually reaches a list of probable causes for the malfunction.

7.3 Special defects

The following types of defects are not indicated on the fault finding diagrams; each of these problems is treated in its own section:

- water leaks;
- difficulty in lighting gas;
- incorrect combustion;
- traces of gas or exhaust gases in the installation area.

7.4 Water leaks

Leaks from connectors, O-rings or gaskets

Make sure that the surfaces which come into contact with the gaskets are free from dirt, roughness or deformation. Then, substitute the gasket (both O-ring and flat gaskets).

Water leaks from the safety valve

This may be caused by leaks from the d.h.w. over-pressurizing the heating circuit.

Make sure that the main circuit pressure gauge is correctly reading the amount of water being used. Remove the d.h.w. heat exchanger and check the bellows for leaks. If necessary, substitute the safety valve.

If the leak only occurs when the appliance is operating, empty the main water circuit and check the pressure applied to the expansion vessel (sect. 6.28).

7.5 Difficulty in lighting the burner

Make sure that input and output pressures on gas valve are set to the correct values.

Also, make sure that no pressure variations are being caused by a malfunctioning component (defective pressure reducers or regulator; dirty gas filters; other gas consuming equipment installed on the same gas line, etc.).

Make sure that the ignition electrode is positioned correctly.

Make sure that injectors are clean.

7.6 Incorrect combustion

Make sure that the gas modulator has been set correctly and make sure that the following elements are clean:

- burner;
- combustion chamber;
- flue system.

Make sure that exhaust flues do not return to the appliance through the air intake duct. Make sure that the flue terminal on the exhaust system has been installed in the correct position (see the installation instructions).

If extension elements have been used in the exhaust duct, make sure that these elements have been inserted correctly.

Please note that the maximum flue length is 3 meters.

7.7 Traces of gas or exhaust flues

If gas is detected in the installation area, use a soap solution or a specific leak-detection product to make sure that all the gas connectors in the system are perfectly sealed. Check for leaks when the appliance is shut down and during operation.

If exhaust flue is detected in the installation area, make sure that the exhaust duct has been built to the exact specifications prescribed. Also, check the exhaust duct for leaks and make sure that it is clean. Make sure that all exhaust duct-work conforms to current technical standards.

7.8 Appliance completely shut down

Initial conditions:

- the function switch is on position ☼
- the thermostat or timer is calling for heat **ref. 1**;
- sufficient gas is being fed to the boiler.

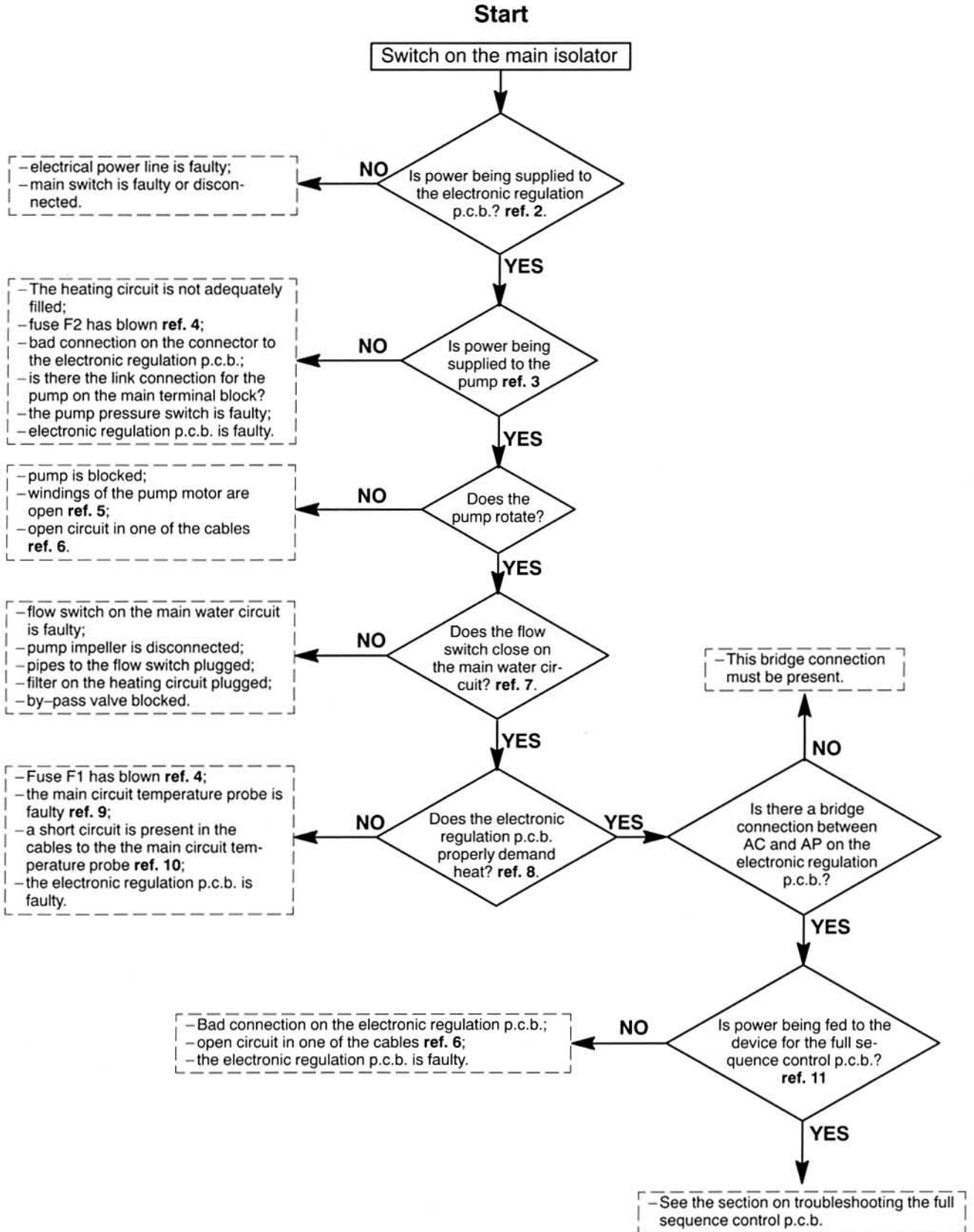

Fault finding

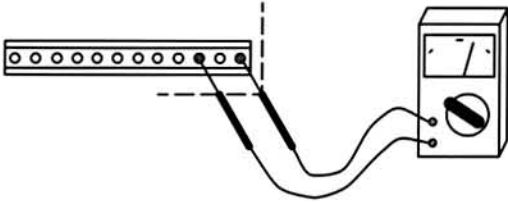

ref. 1 Supply voltage should be indicated when the appliance is started and when the thermostat or timer is open.
Set the tester to VAC

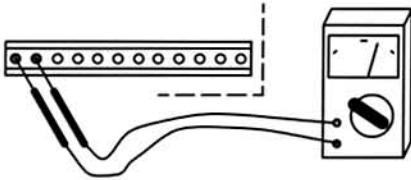

ref. 2 Supply voltage should be indicated when power is supplied to the electronic regulation p.c.b.
Set the tester to VAC

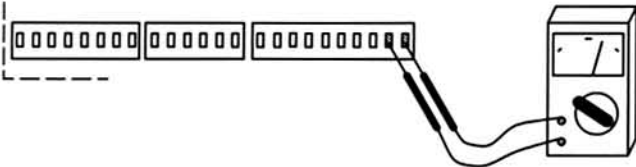

ref. 3 Supply voltage should be indicated when power is supplied to the pump.
Set the tester to VAC

ref. 4 A fuse generally blows because of an overload. To locate the cause, disconnect the components connected to the board and measure their electric resistance; see ref. 5.
Spare fuses are available in housing of the electronic regulation p.c.b.

ref. 5 To check a winding, disconnect the winding from its circuit and measure the resistance in the winding (set tester to ohm):

| | |
|-----------------------|-----------|
| Pump | 180 ohm |
| upper on-off operator | 4 000 ohm |
| lower on-off operator | 870 ohm |
| Fan | 100 ohm |
| 3-way valve | 1 700 ohm |

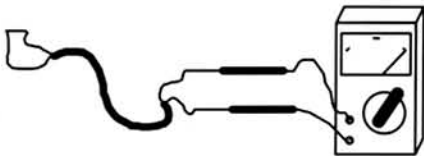

ref. 6 To check the continuity of a cable, disconnect the cable from its circuit and measure the resistance when the two ends of the cable are connected. The resistance should be zero ohms with the tester set to the ohms function.
Set tester to ohm.

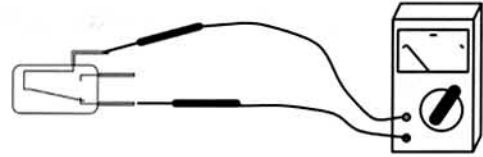

ref. 7 Disconnect the terminals from the microswitch on the flow switch and measure the resistance. When the appliance is switched off the resistance should be infinity; when the appliance is switched on the resistance should go to zero ohms. Set tester to ohm.
To avoid electric shocks carefully insulate the electric terminals on the cable before this test.

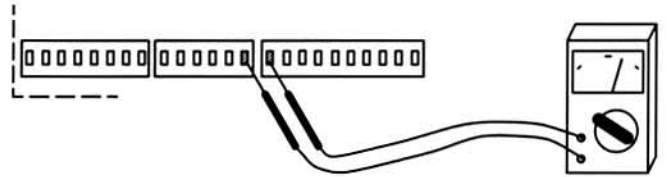

ref. 8 Supply voltage should be present across these terminals when there is a demand for heat.
Set the tester to VAC

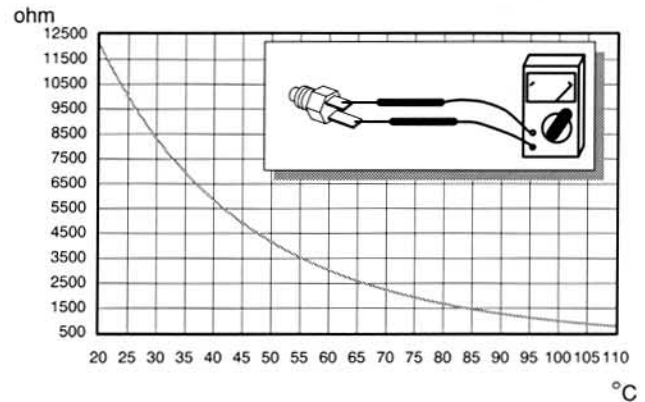

ref. 9 The resistance of the temperature probe depends on its temperature (18 000 ohm at 10°C).
See the diagram for proper electric resistance at other temperatures. Set tester to ohm.

ref. 10 Disconnect the cable from the temperature probe to the electronic regulation p.c.b. at both ends and measure the resistance between the two wires in the cable, which should be infinity. Set tester to ohm.

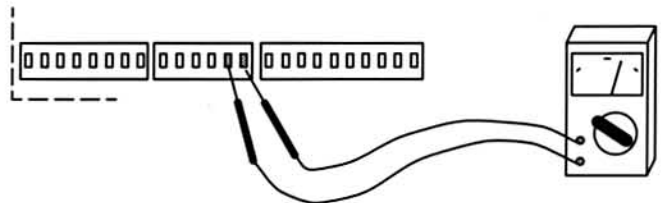

ref. 11 Supply voltage should be indicated when power is supplied to the full sequence control p.c.b.
Set the tester to VAC

7.9 Fault of full sequence control p.c.b.

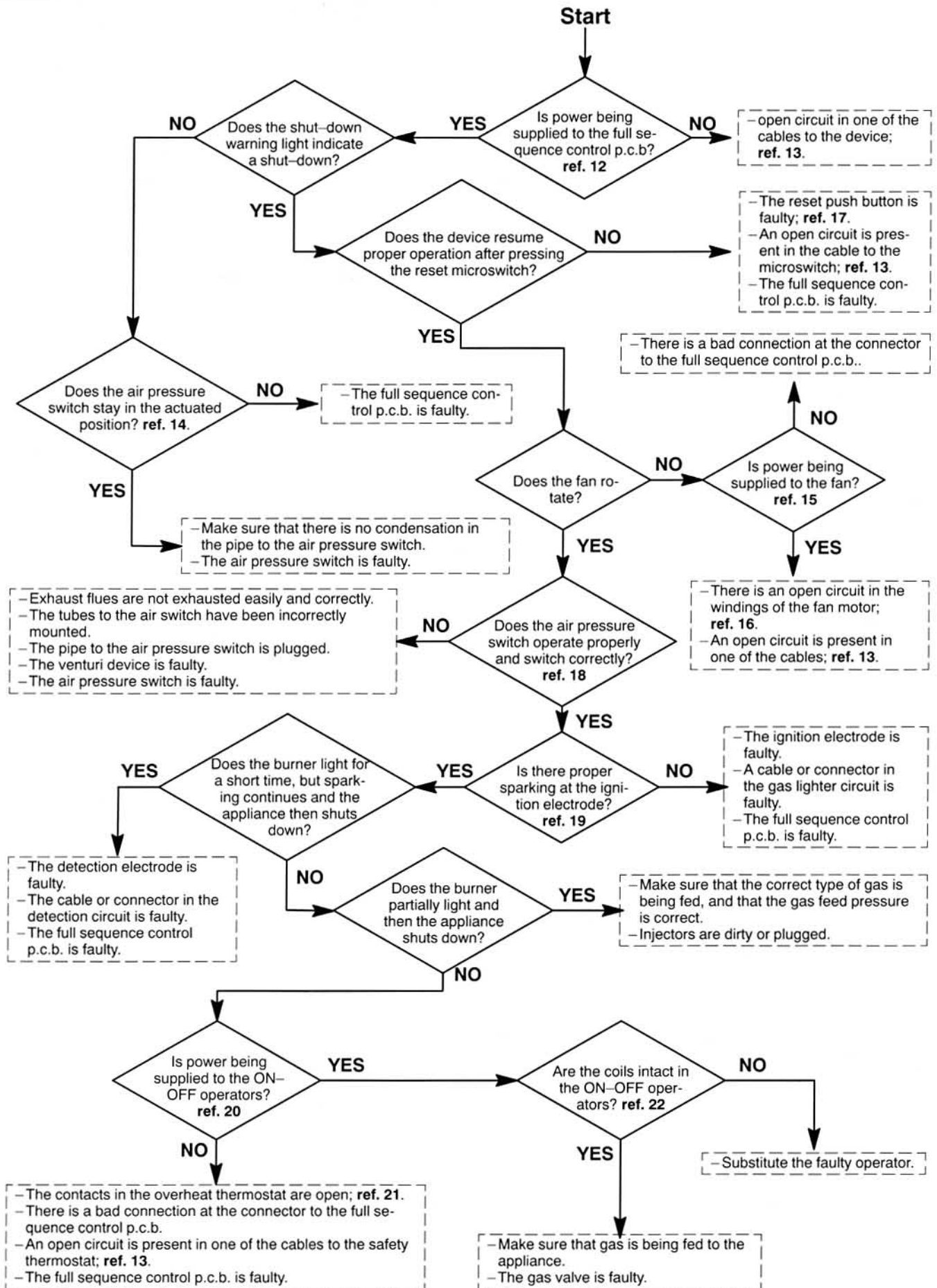

Fault finding

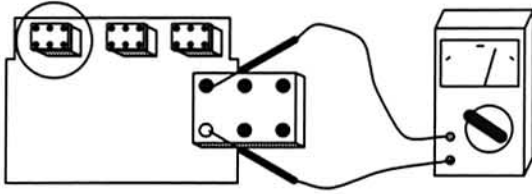

ref. 12 Supply voltage should be indicated when power is supplied to the device. Set tester to VAC.



ref. 13 To check the continuity of a cable, disconnect the cable from its circuit and measure the resistance when the two ends of the cable are connected. The resistance should be zero ohms. Set tester to ohm.

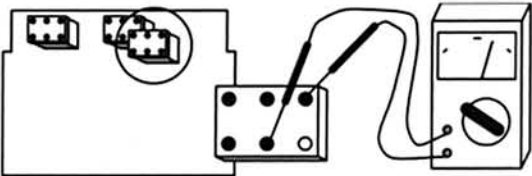

ref. 14 Disconnect the connector from the device and measure the resistance. If the contact has remained in the actuated position, the resistance will be zero ohm. Set tester to ohm.

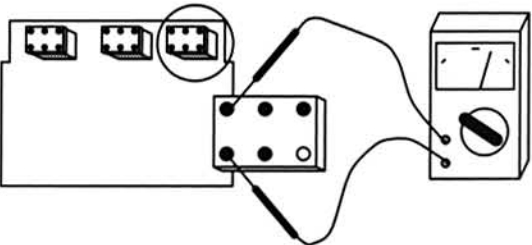

ref. 15 Supply voltage should be indicated when power is supplied to the fan motor. Set tester to VAC.

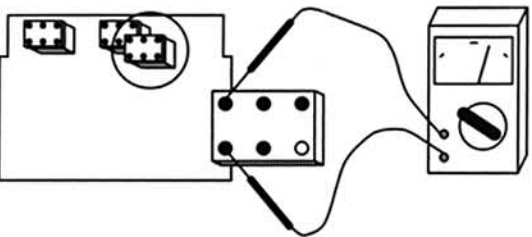

ref. 16 Disconnect the connector from the device and measure the resistance. If an open circuit is present in the motor windings or in the cables to the fan, no indication will appear on the tester. Set tester to ohm.

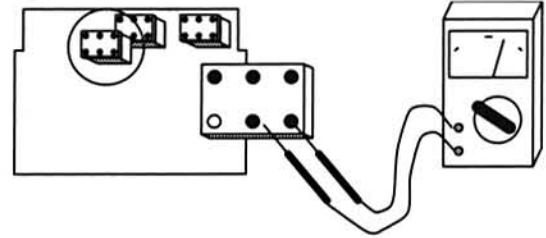

ref. 17 Disconnect the connector from the device and measure the resistance. The tester should indicate zero ohms when the microswitch is actuated. Set tester to ohm.

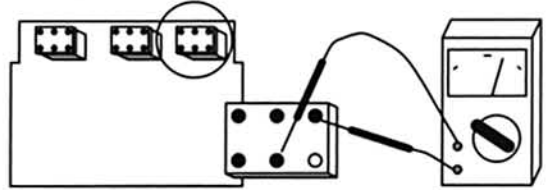

ref. 18 If approx. 16VDC is present across the terminals shown in the diagram, the air pressure switch is not switching properly. Set tester to VDC.

ref. 19 The sparks from the lighter must be positioned perpendicular to the burner ramp. The distance from the electrode to the ramp must be 5 mm.

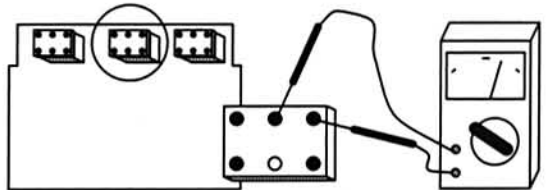

ref. 20 Supply voltage should be indicated when power is supplied to the operators. Set tester to VAC with the device reset from shut-down. Set tester to VAC.

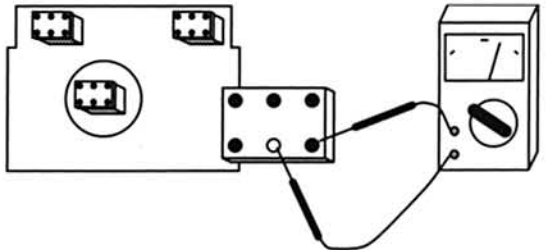

ref. 21 Disconnect the connector from the device and measure the resistance. If the contacts in overheat thermostat are open no indication will appear on the tester. Set tester to ohm.

ref. 22 To check the coil in the on-off operators, disconnect the winding from its circuit and measure the resistance in the winding (set tester to ohm):

| | |
|-----------------------|-----------|
| upper on-off operator | 4 000 ohm |
| lower on-off operator | 870 ohm |

7.10 Fault on d.h.w. – c.h. switching

Initial conditions:

- the function switch is in position. ☼
- the thermostat or timer is calling for heat **ref. 23**.
- The lever on the 3-way valve is set to "automatic"; **ref. 24**.

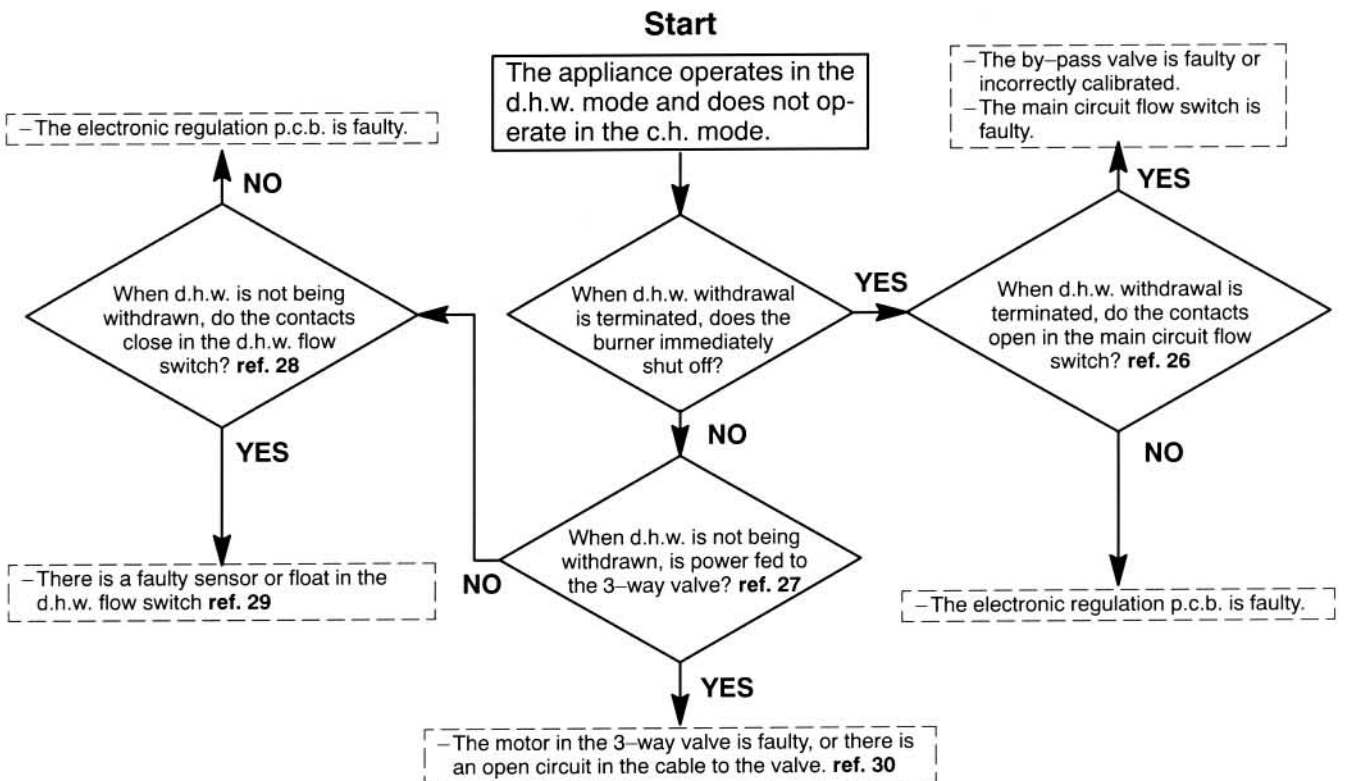
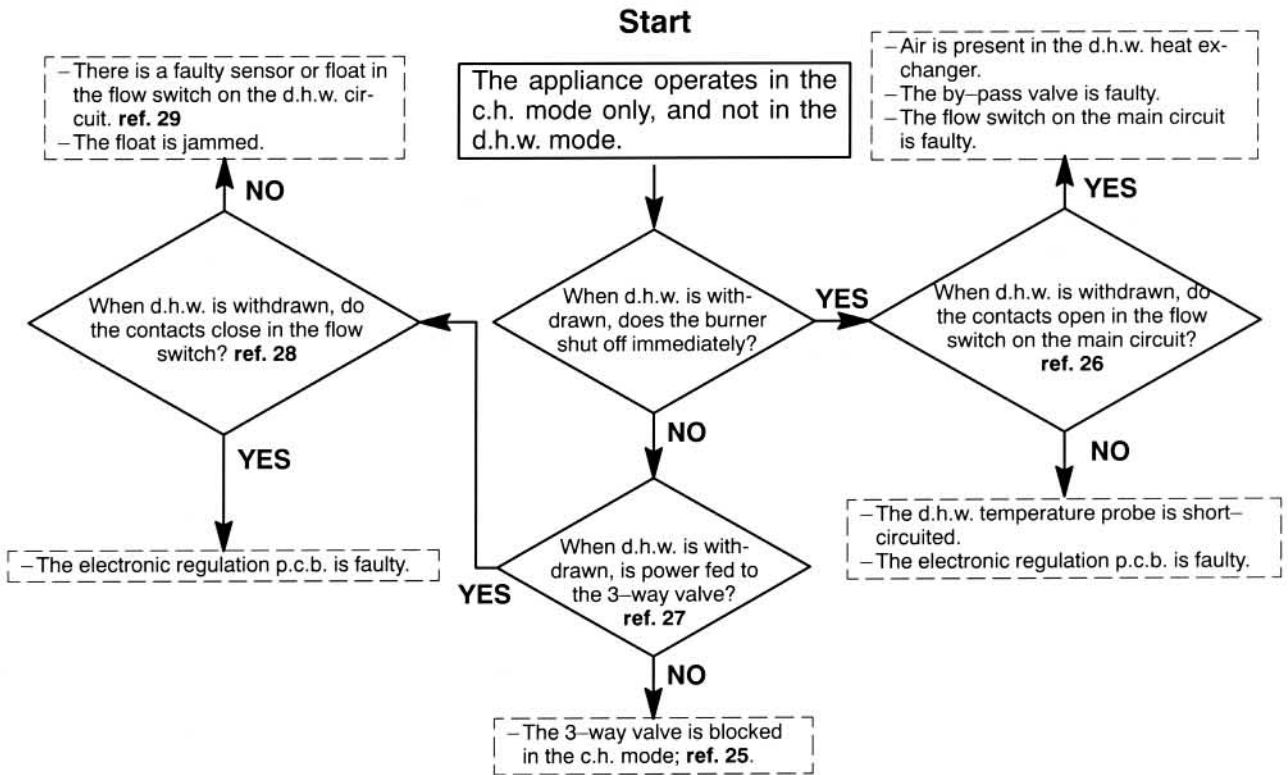

Fault finding

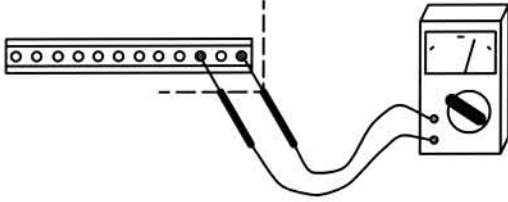

- ref. 23 Supply voltage should be indicated when the appliance is started with an open thermostat or timer. Set the tester to VAC.

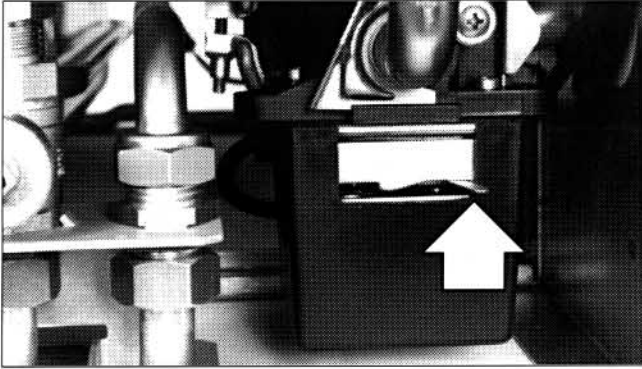

- ref. 24 The correct position of the lever on the 3-way valve during normal operation is shown in the picture (the lever should be positioned toward the right, as seen from the front of the appliance).
- ref. 25 If power is not being supplied to the 3-way valve, the lever must move freely over the first half of its travel from left to right. Also, the lever must meet resistance when moved over the remaining half of its travel from left to right. If the lever moves freely from left to right over its entire travel, the 3-way valve is jammed or faulty. Substitute the valve.

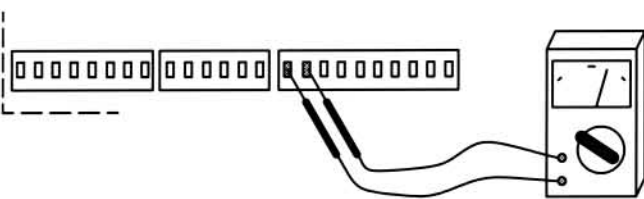

- ref. 26 When the contacts open in the main circuit flow switch, the voltage across the points shown in the diagram should increase from 0 volts to supply voltage. Set the tester to VAC.

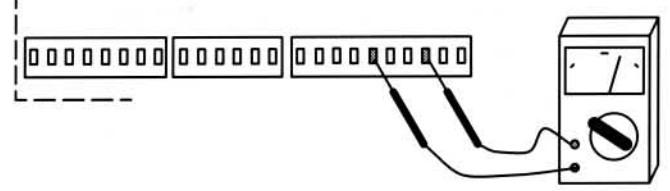

- ref. 27 Power is being supplied to the 3-way valve when supply voltage is measured across the points shown in the diagram. Set the tester to VAC.

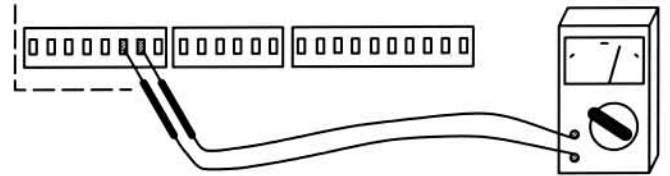

- ref. 28 If 12 VDC is measured across the points shown in the diagram, the contacts are open in the d.h.w. flow switch. If 0 volts are measured, the contacts are closed. Set the tester to VDC.

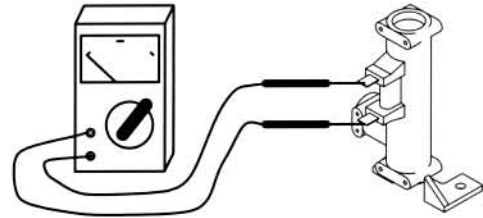

- ref. 29 Disconnect the flow switch on the d.h.w. circuit and connect an ohmmeter as shown above. The contact in the sensor on the flow switch is normally open (resistance at infinity). Withdrawing a sufficient quantity of d.h.w. the contact must close (resistance zero). Set the tester to ohm.

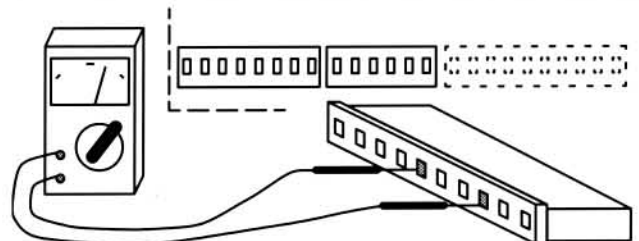

- ref. 30 At the electronic regulation p.c.b, disconnect the cable from the 3-way valve to the board. Measure the resistance across the cable, which should be 1700 ohm. Set the tester to ohm.

7.11 Fault on modulation

Initial conditions:

- C.h. and d.h.w. temperature adjustments on **maximum** position.
- Low temperature on c.h. and d.h.w. circuits.

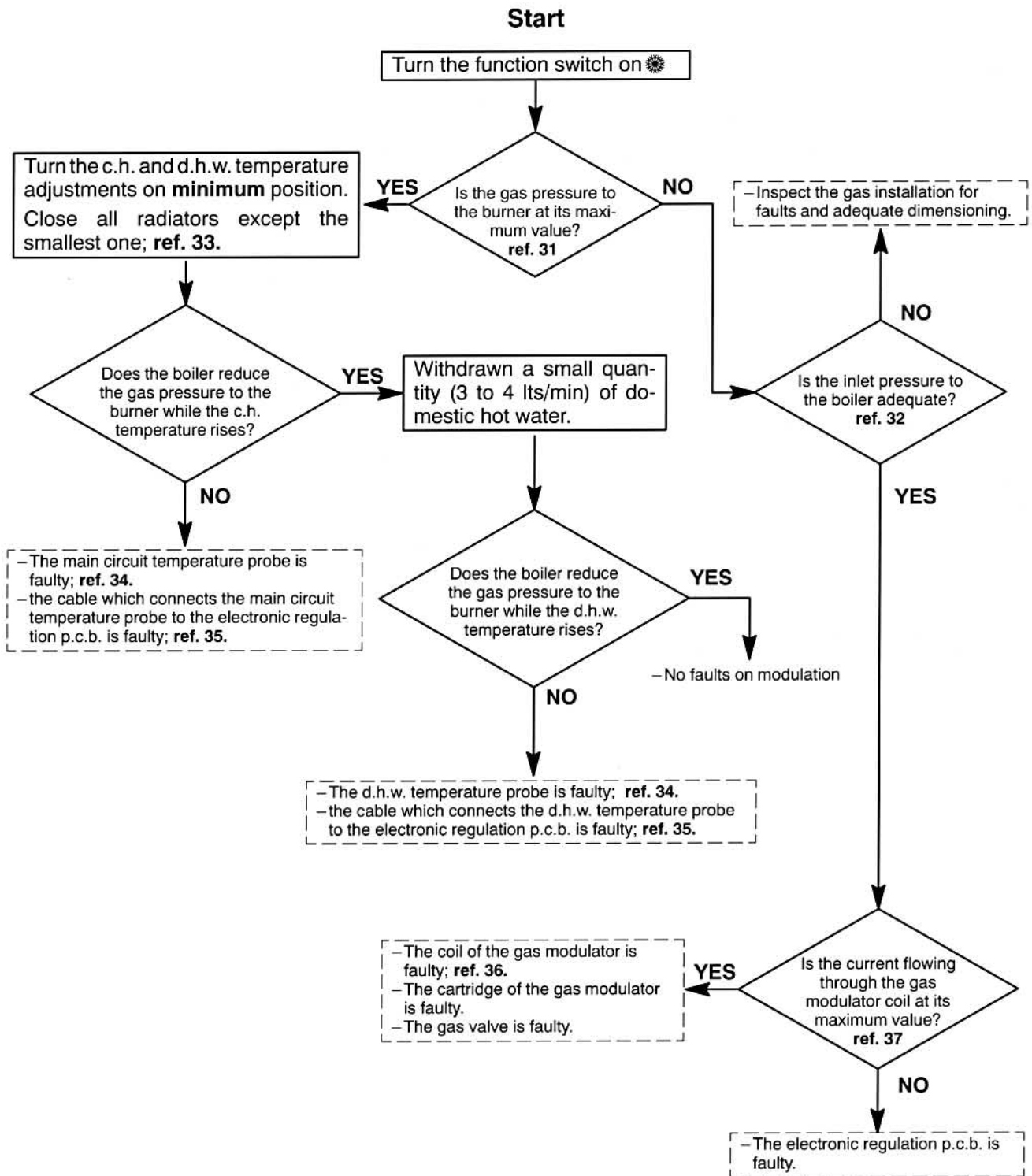

Fault finding

- ref. 32 Check the gas pressure at the test point for measuring outlet pressure at the gas valve and compare with the value on sect. 1.2.

- ref. 33 Check the gas pressure at the test point for measuring inlet pressure at the gas valve and compare with the value on sect. 1.2.

- ref. 34 e.g. leave the smallest radiator open and close the others.

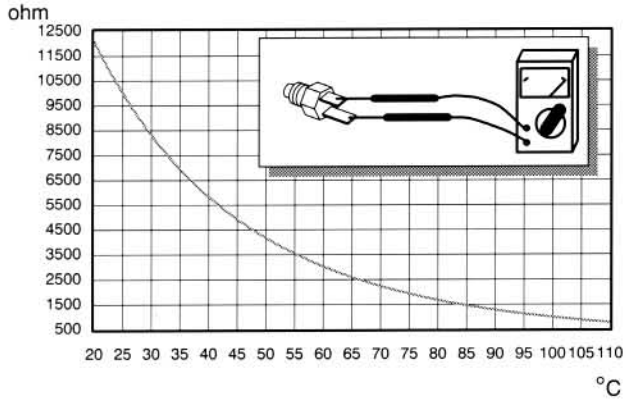

- ref. 34 The resistance of the temperature probe depends on its temperature (18 000 ohm at 10 °C). See the diagram for proper electric resistance at other temperatures. Set the tester to ohm.

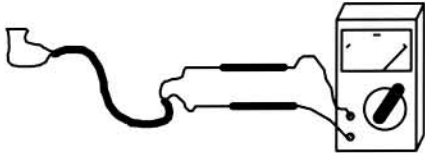

- ref. 35 To check the continuity of a cable, disconnect the cable from its circuit and measure the resistance when the two ends of the cable are connected. The resistance should be zero ohms with the tester set to the ohms function. Set the tester to ohm.

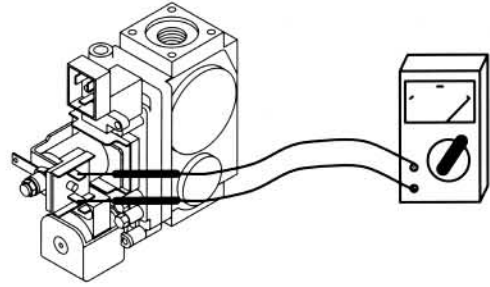

- ref. 36 To check the coil of the gas modulator disconnect the winding from its circuit and measure the resistance in the winding (set the tester to ohm):
Gas modulator coil 125 ohm

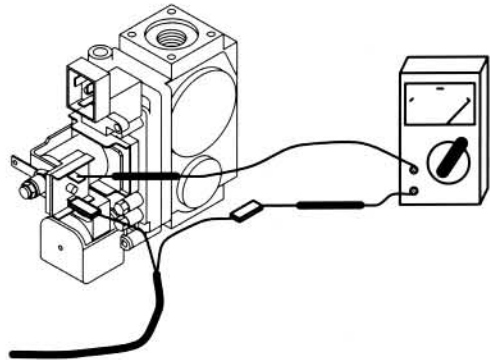

- ref. 37 To check the current flowing through the gas modulator coil disconnect one of the connectors and insert the ammeter (200 mA= full-scale minimum) between the connector and the terminal of the coil. To obtain the maximum gas pressure to the burner the current must be at least 150 mA=. Set the tester to ADC.

8 ELECTRIC DIAGRAMS

8.1 General wiring layout

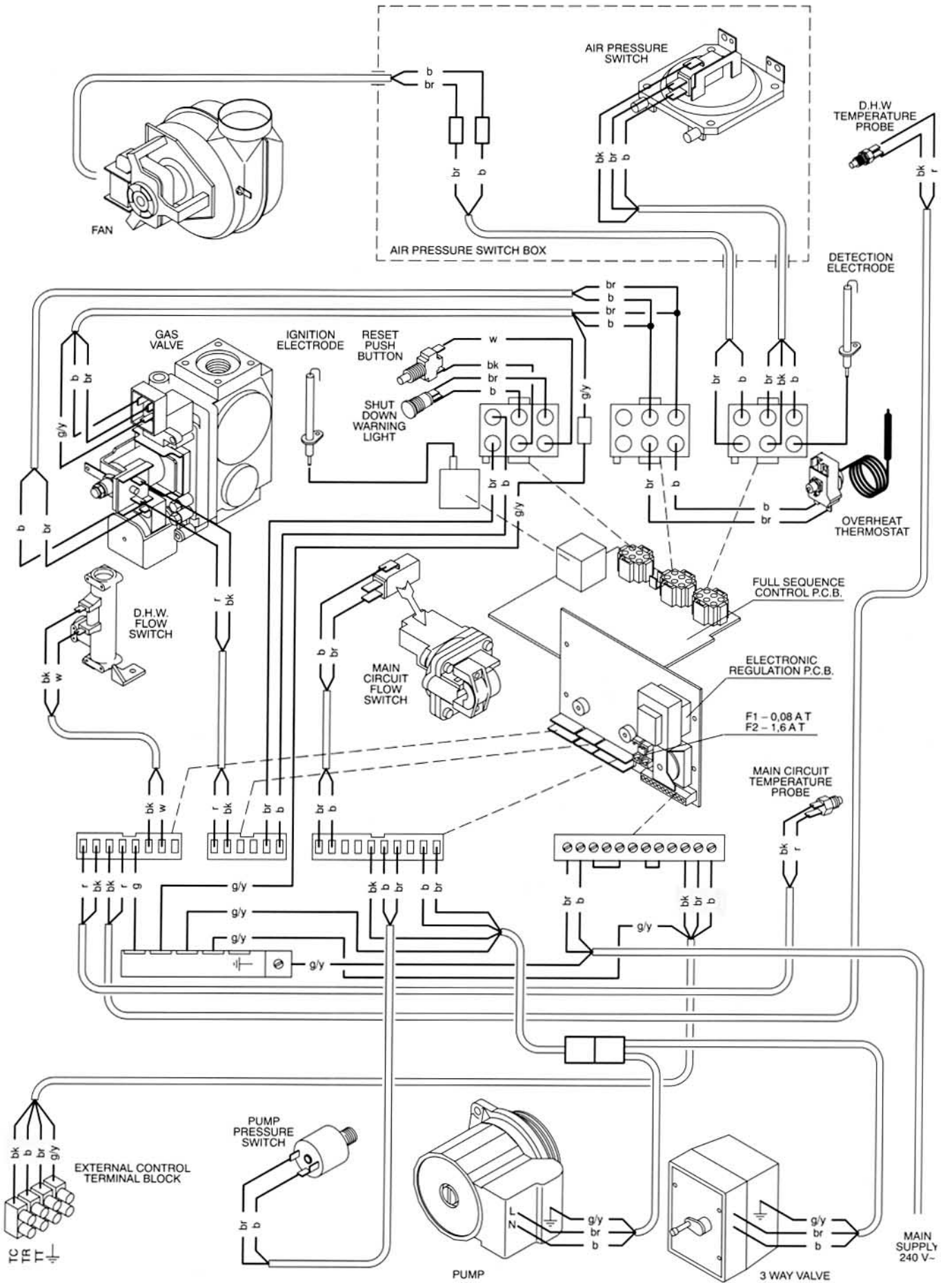

8.2 Functional flow diagrams

General layout
function switch position: off

L - LINE N - NEUTRAL

————— ACTIVATED CIRCUIT
————— NON ACTIVATED CIRCUIT

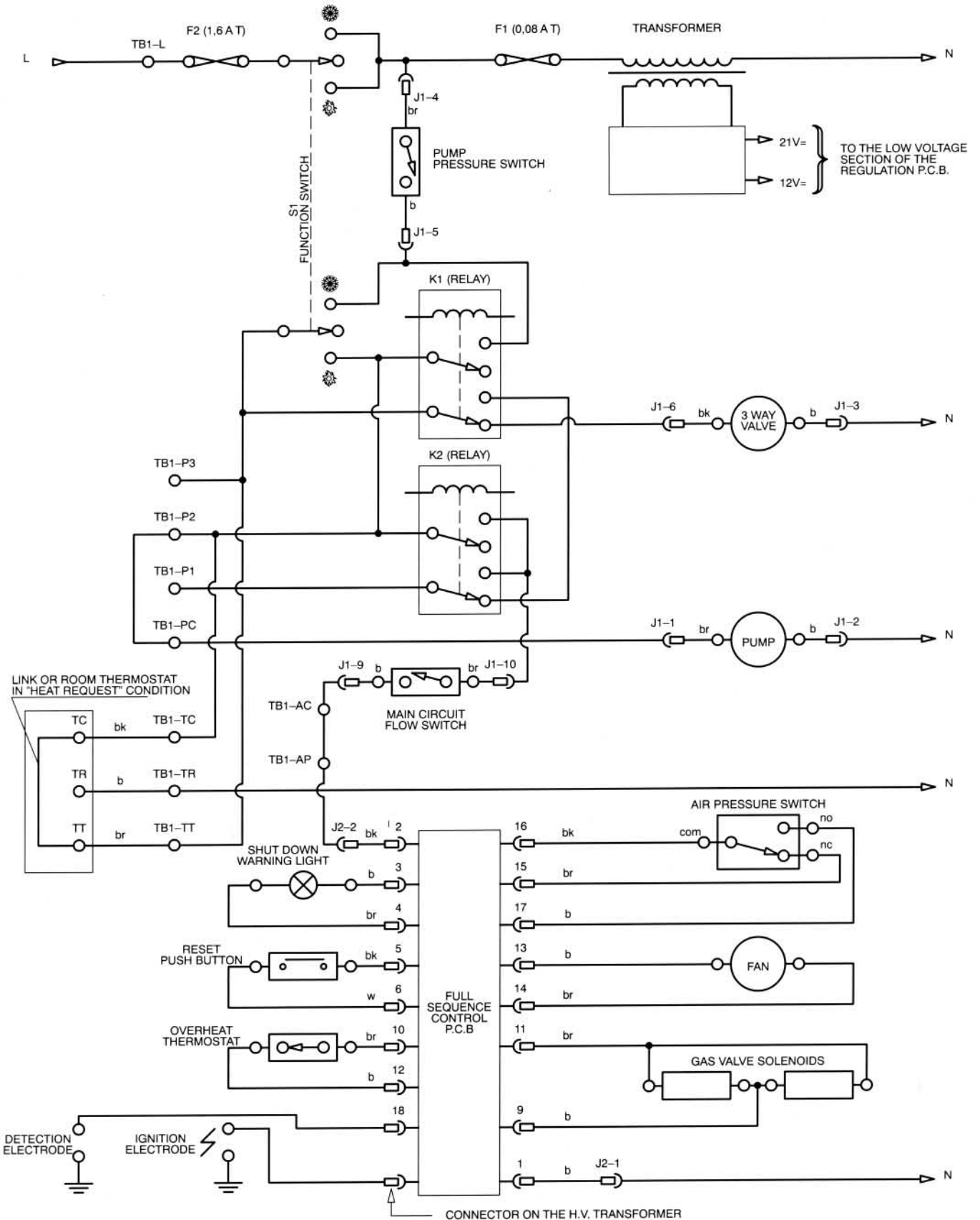

Electric diagrams

Function switch position 
Heat request on c.h.

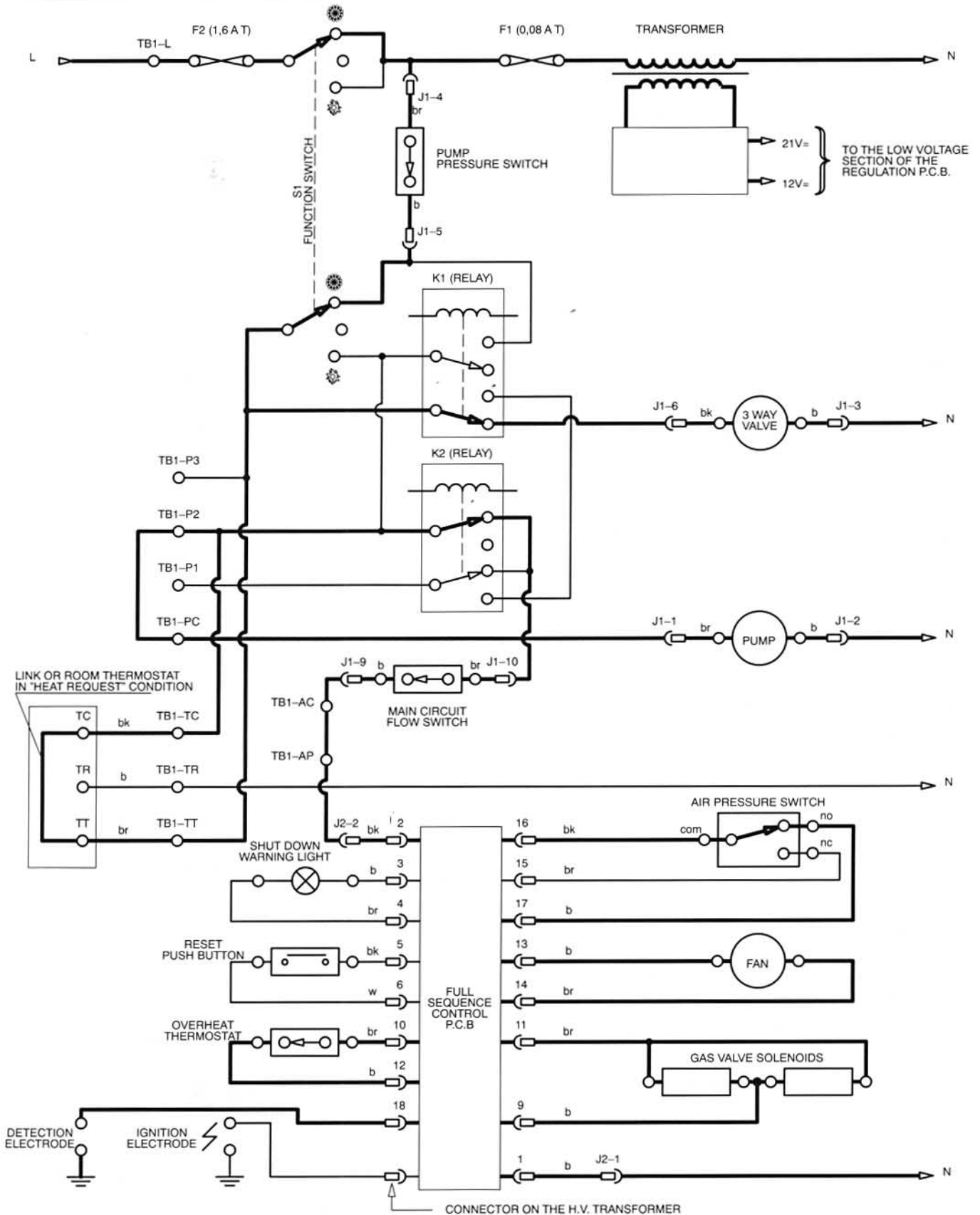

L - LINE N - NEUTRAL
 ACTIVATED CIRCUIT
 NON ACTIVATED CIRCUIT



Electric diagrams

Function switch position 
Heat request on d.h.w.

L - LINE N - NEUTRAL

 ACTIVATED CIRCUIT
 NON ACTIVATED CIRCUIT

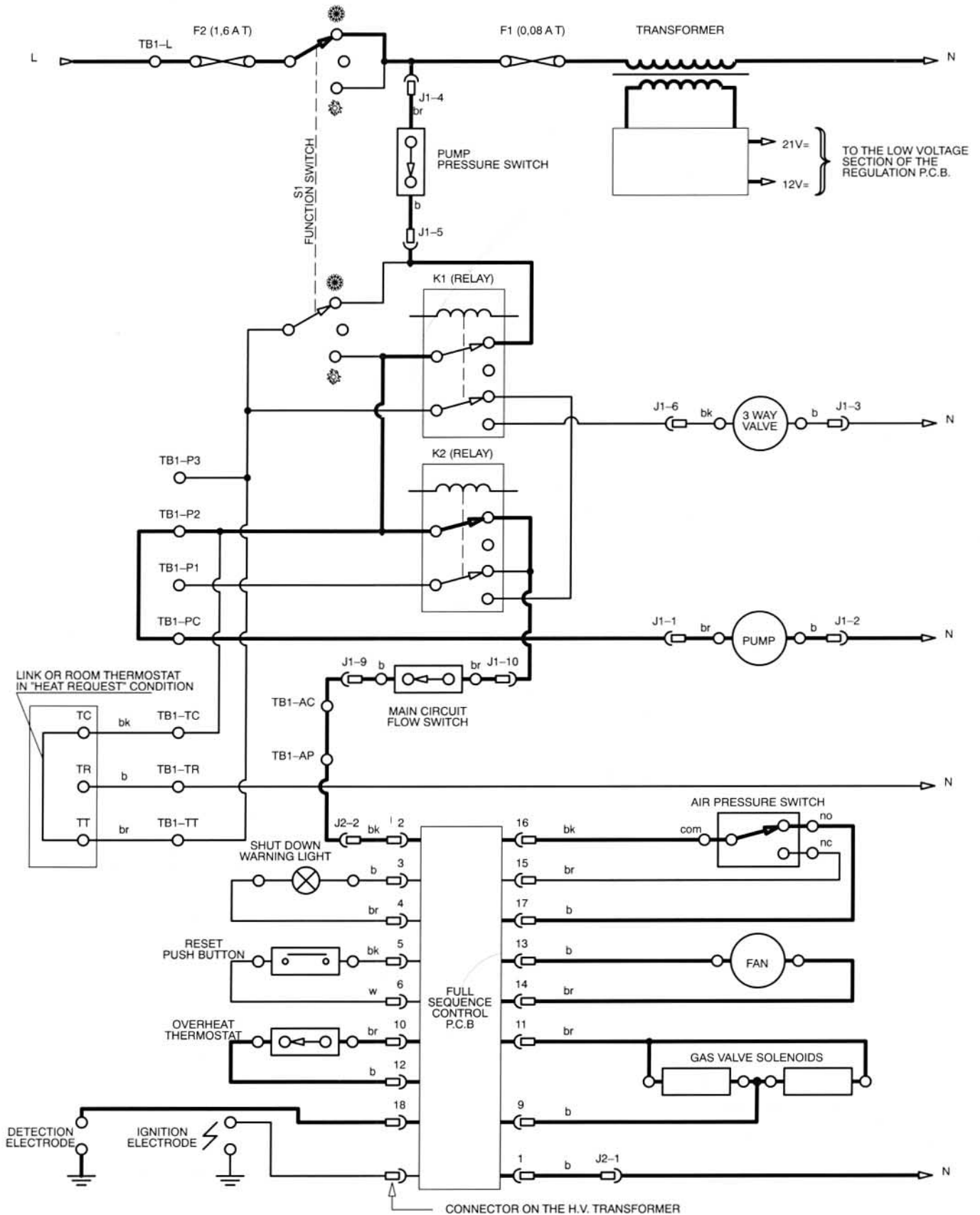

Electric diagrams

Function switch position 
Heat request on d.h.w.

L - LINE N - NEUTRAL

 ACTIVATED CIRCUIT
 NON ACTIVATED CIRCUIT

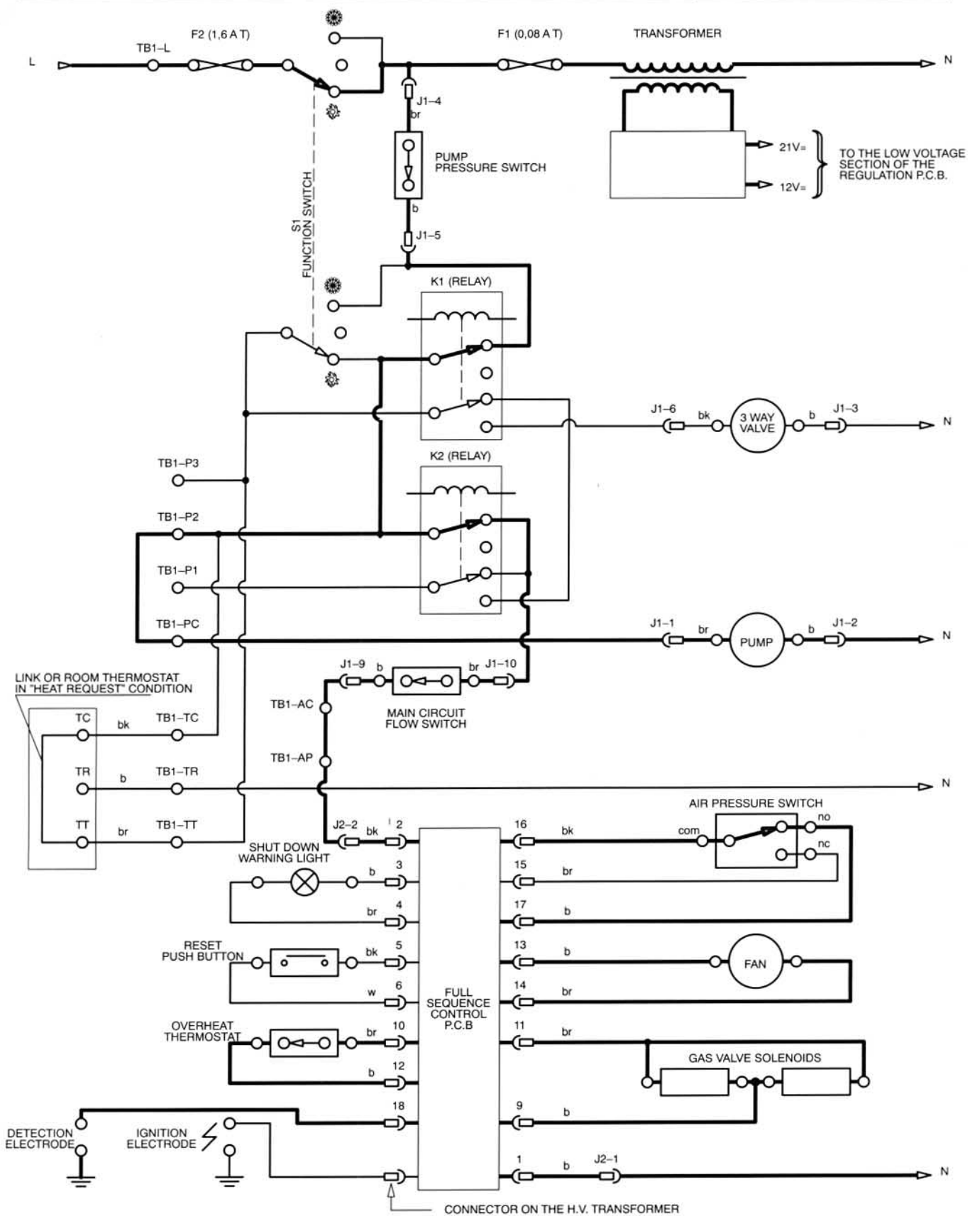



9 SHORT SPARE PARTS LIST

| Key no. | G.C. part no. | Description | Manufacturer's reference | No. | Ariston Part No. |
|---------|---------------|--|--|-----|------------------|
| 1 | 164 080 | 12 ramps burner | | 1 | KG2004 101 |
| 2 | 379 102 | Injectors (including copper gaskets) | Polidoro ø 1.35 mm | 12 | KG2004 106 |
| 3 | 379 083 | Gas modulator cartridge | SIT Control 0.928.850 | 1 | KG2004 117 |
| 4 | 379 081 | Gas valve | SIT Control 827 Nova 0.827.150 | 1 | KG2004 113 |
| 5 | 379 097 | Expansion vessel (including gasket) | | 1 | KG2003 136 |
| 6 | 164 006 | D.h.w. bellows (including O-rings) | | 1 | KG2001 108 |
| 7 | 164 079 | Main heat exchanger (including gaskets) | | 1 | KG2003 157 |
| 8 | | Fan | | 1 | |
| 9 | 379 091 | Air pressure switch | Yamatake-Honeywell C6065A1010 | 1 | KG2027 101 |
| 10 | 164 163 | Front combustion chamber insulation panel | | 1 | KG2017 106 |
| 11 | 164 166 | Side combustion chamber insulation panel | | 1 | KG2017 109 |
| 12 | 164 159 | Rear combustion chamber insulation panel | | 1 | KG2017 101 |
| 13 | 386 714 | D.h.w. expansion vessel (optional) | | 1 | KG2001 130 |
| 14 | 379 085 | Safety valve (including gaskets) | Caleffi 512 1/2" | 1 | KG2005 108 |
| 15 | 164 056 | Pump (including gasket) | | 1 | KG2002 132 |
| 16 | 379 092 | 3 way valve (including shutter and O-ring) | MUT SF20 (without deviation body) | 1 | KG2002 103 |
| 17 | 164 074 | Main circuit flow switch | | 1 | KG2003 152 |
| 18 | 164 011 | D.h.w. flow switch (complete) | | 1 | KG2001 113 |
| 19 | 164 126 | Electronic regulation p.c.b. | | 1 | KG2006 122 |
| 20 | 164 112 | Full sequence control p.c.b. | | 1 | KG2006 106 |
| 21 | 379 080 | Pump pressure switch | CEME | 1 | KG2002 129 |
| 22 | 379 086 | Overheat thermostat | FIRT STB/901 | 1 | KG2006 112 |
| 23 | 164 119 | Fuse 0,08 A T (F1) | | 1 | KG2006 115 |
| 24 | 164 120 | Fuse 1,6 A T (F2) | | 1 | KG2006 116 |
| 25 | 164 026 | D.h.w. temperature probe (including gasket) | | 1 | KG2001 128 |
| 26 | 164 026 | Main circuit temp. probe (including gasket) | | 1 | KG2001 128 |
| 27 | 379 079 | Automatic air release valve (including O-ring) | Caleffi "robocal" 5030 3/8" GAS 502630 | 1 | KG2001 101 |
| 28 | 164 081 | Ignition electrode | | 1 | KG2004 102 |
| 29 | 164 081 | detection electrode | | 1 | KG2004 102 |
| 30 | 379 088 | Shut down warning light | | 1 | KG2006 128 |
| 31 | 379 087 | Reset push button | | 1 | KG2006 111 |
| 32 | 164 117 | Temperature-pressure gauge (including gasket) | | 1 | KG2006 113 |
| 33 | 164 210 | Flat gasket pack (complete) | | 1 | KG2009 101 |
| 34 | 164 211 | O-ring pack (complete) | | 1 | KG2009 102 |

Short spare parts list

